

NAME

TATONKA®



OVERVIEW

**HARDWARE**

2027\_1

### FAIRE & TRANSPARENTE PRODUKTION

Die Hardware von Tatonka wird nach europäischen Fertigungsstandards und unter sozialverträglichen Bedingungen in unseren eigenen Werken in Vietnam hergestellt. Mit unserem Programm **OPEN FACTORY** haben Sie immer freitags die Möglichkeit, das Werk Mountech Co. Ltd. bei laufendem Produktionsbetrieb zu besichtigen. **Herzlich Willkommen!**

### FAIR & TRANSPARENT PRODUCTION

Tatonka hardware is made to European manufacturing standards under socially responsible conditions at our own works in Vietnam. Under our **OPEN FACTORY** programme, you are welcome to visit the Mountech Co. Ltd. factory on any Friday and watch it in operation. **Welcome!**

[openfactory.tatonka.com](https://openfactory.tatonka.com)

## OVERVIEW

Neukunden können hier die Overview herunterladen /  
New customers can download the overview here:

<https://nc.tatonka.com/index.php/s/ettCXomt9799ZRX>





## WELCOME TO OUR WORLD

TREKKING BACKPACKS	4	SMALL BAGS	50
HIP BELT BAGS	6	STUFFBAGS HF WELDED	55
LOAD CARRIER	6	POUCHES & STUFF BAGS	57
MULTI DAY HIKER	7	TENSION STRAPS & PACKING AIDS	59
HIKING BACKPACKS	9	MUGS & CUPS	60
BIKE PACKS	12	PLATES & BOWLES	62
BIKE BAGS	13	POTS & PANS	63
BIKE EQUIPMENT	14	STOVES & ACCESSORIES	65
DAYPACKS	16	CUTLERY	66
TOTE BAGS & SHOULDER BAGS	21	KITCHEN SETS	67
KIDS' BACKPACKS	22	STORAGE CONTAINER	68
TRAVEL BACKPACKS	24	BOTTLES & ACCESSORIES	70
TRAVEL BAGS	25	SEATS & SEAT MATS	72
LIGHTWEIGHT ACCESSORIES	28	MOSQUITO PROTECTION	73
WASH BAGS	30	TARPS	74
HIP BAGS	31	TENT ACCESSORIES	76
TRAVEL SAFETY	33	TREKKING TENTS	80
WALLETS & DOCUMENT BAGS	36	FAMILY TENTS	84
BELTS	38	SPECIAL TENTS	84
CAPES & PONCHOS	40	MERCHANDISING	86
GAITERS	41	LIST OF SHORTCUTS	86
FIRST AID	42		
BACKPACK ACCESSORIES	44		
PHOTO BAGS	47		
COOLER BAGS	48		
TREK & TRAVEL ACCESSORIES	49		

**NEW** New Article

**UPDATE** Product Update

**NEW COLOR** New Color

## 1320 YUKON X1 65+10 WOMEN

CORDURA® 500 den / Microrip 2.1 / 77 x 33 x 24 cm / 3,36 kg / 75 l



037 midnight plum

## 1321 YUKON X1 75+10

CORDURA® 500 den / Microrip 2.1 / 82 x 35 x 24 cm / 3,63 kg / 85 l



004 navy

## 1322 YUKON X1 85+10

CORDURA® 500 den / Microrip 2.1 / 86 x 38 x 24 cm / 3,74 kg / 95 l



040 black

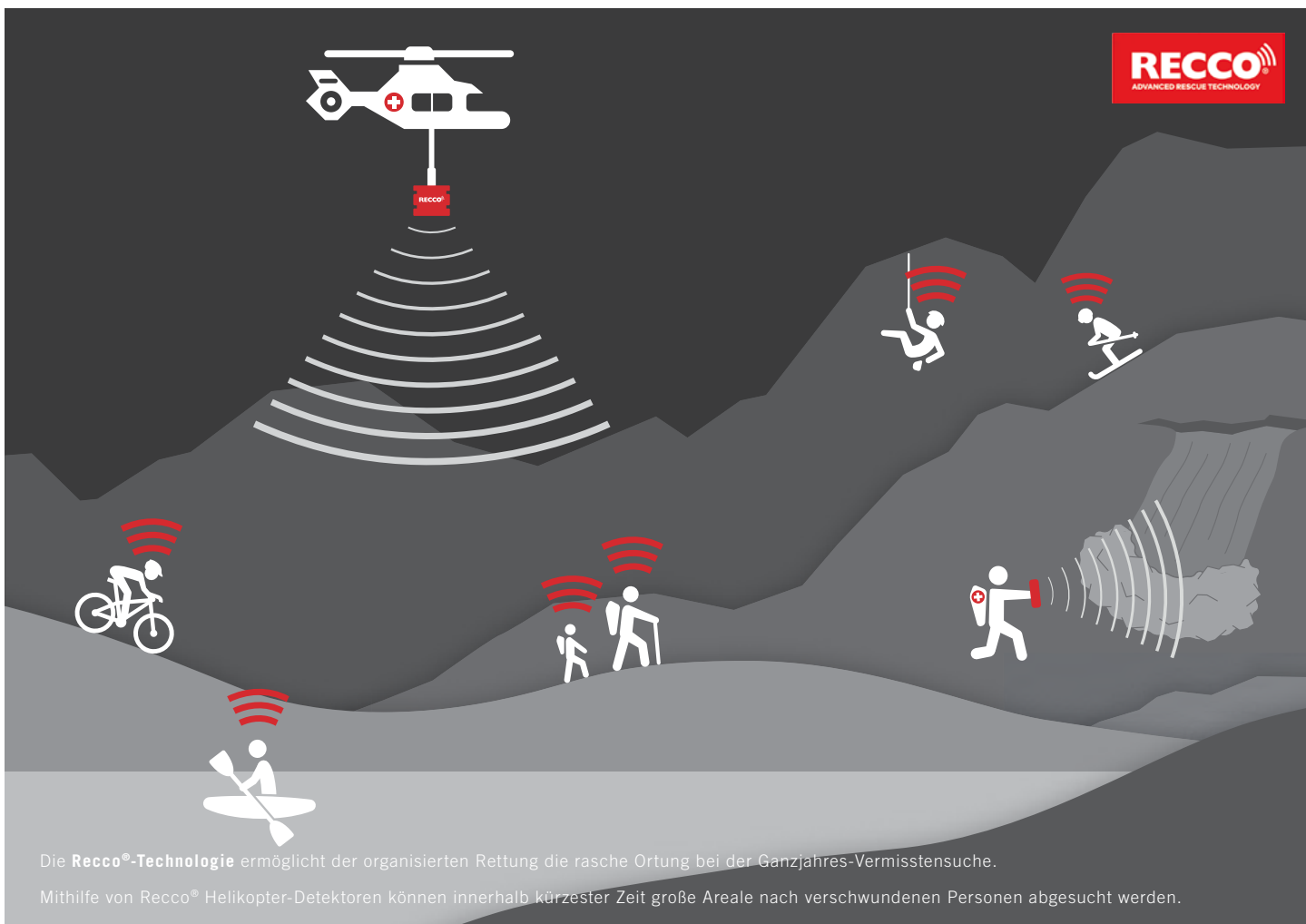

**RECCO**  
ADVANCED RESCUE TECHNOLOGY

Die Recco®-Technologie ermöglicht der organisierten Rettung die rasche Ortung bei der Ganzjahres-Vermisstensuche. Mithilfe von Recco® Helikopter-Detektoren können innerhalb kürzester Zeit große Areale nach verschwundenen Personen abgesucht werden.



## 1448 NORAS 55+10 WOMEN

Textreme 6.6 Recycled / Microrip 2.1 / 75 x 30 x 18 cm / 1,85 kg / 65 l



004 navy



037 midnight plum

## 1449 NORAS 65+10

Textreme 6.6 Recycled / Microrip 2.1 / 78 x 32 x 22 cm / 2,60 kg / 75 l



040 black



277 jasper

## 1336 HIP BELT POUCH S

Textreme 6.6 Recycled / 26 x 16 x 8 cm / 130 g / 2 l

fits to: YUKON; NORAS, LASTENKRAXE



004 navy



021 titan grey



040 black



037 midnight plum



277 jasper

## 1340 HIP BELT POUCH

Textreme 6.6 Recycled / 26 x 15 x 9 cm / 110 g / 3 l

fits to: YUKON, NORAS, LASTENKRAXE



004 navy



021 titan grey



040 black



037 midnight plum



277 jasper

## 1130 LASTENKRAXE

420 HD Nylon FD / Aluminiumrahmen / 78 x 35 x 28 cm / 2,70 kg



040 black



331 olive

## 1133 PACKSACK 2 LASTENKRAXE

420 HD Nylon FD / CORDURA® 500 den / 66 x 34 x 25 cm / 850 g / 80 l



040 black



331 olive



### 1418 PYROX 40+10 WOMEN BC

RAINCOVER

CORDURA® 500 den / Tex Cover Recycled / 70 x 29 x 16 cm / 2,34 kg / 50 l



040 black



332 stone grey olive

### 1419 PYROX 45+10 BC

RAINCOVER

CORDURA® 500 den / Tex Cover Recycled / 73 x 29 x 17 cm / 2,48 kg / 55 l



040 black



332 stone grey olive

### 1389 PYROX LITE 48+10

70DEN RipStop UTS / 210 HD Nylon FD / 76 x 30 x 17 cm / 1,30 kg / 58 l



021 titan grey

### 1391 PYROX LITE 44+10 WOMEN

70DEN RipStop UTS / 210 HD Nylon FD / 70 x 29 x 16 cm / 1,20 kg / 54 l



021 titan grey

### 1371 PYROX 35+10 WOMEN SHORT

RAINCOVER

NEW

100 den Honeycomb Recycled / Microrip 2.1 / 67 x 28 x 15 cm / 1,84 kg / 45 l



286 sage green

### 1420 PYROX 40+10 WOMEN

RAINCOVER

100 den Honeycomb Recycled / Microrip 2.1 / 67 x 28 x 15 cm / 1,82 kg / 50 l



040 black



279 elemental blue



286 sage green

### 1424 PYROX 45+10

RAINCOVER

100 den Honeycomb Recycled / Microrip 2.1 / 73 x 30 x 17 cm / 1,93 kg / 55 l



040 black



274 darker blue



286 sage green

### 1373 PYROX 48+10 LONG

RAINCOVER

NEW

100 den Honeycomb Recycled / Microrip 2.1 / 79 x 30 x 17 cm / 2,16 kg / 58 l



040 black

### 1388 NORIX 44 WOMEN

RAINCOVER

Textreme 6.6 Recycled / Microrip 2.1 / 70 x 32 x 18 cm / 1,89 kg / 44 l



037 midnight plum



040 black

### 1387 NORIX 48

RAINCOVER

Textreme 6.6 Recycled / Microrip 2.1 / 72 x 29 x 16 cm / 2,00 kg / 48 l



004 navy



040 black

### 1443 AKELA 35

Snow Crust / 420 HD Nylon FD / 59 x 27 x 18 cm / 1,40 kg / 35 l



040 black



332 stone grey olive

### 1444 AKELA 45

Snow Crust / 420 HD Nylon FD / 69 x 28 x 19 cm / 1,53 kg / 45 l



040 black



332 stone grey olive



**1567 HIKE PACK 25 WOMEN BC** RAINCOVER NEW COLOR

CORDURA® 500 den / 420 HD Nylon FD / 52 x 27 x 15 cm / 1,04 kg / 25 l



040 black

332 stone grey olive

**1542 HIKE PACK 30 BC** RAINCOVER NEW COLOR

CORDURA® 500 den / 420 HD Nylon FD / 57 x 27 x 16 cm / 1,65 kg / 30 l



040 black

332 stone grey olive

**1579 HIKE PACK 16 WOMEN** RAINCOVER NEW

Microrip 2.1 / 51 x 24 x 13 cm / 885 g / 16 l



021 titan grey

037 midnight plum

**1577 HIKE PACK 19 WOMEN** RAINCOVER NEW

Microrip 2.1 / 47 x 23 x 12 cm / 870 g / 19 l



021 titan grey

037 midnight plum

**1581 HIKE PACK 22** RAINCOVER NEW

Microrip 2.1 / 55 x 24 x 14 cm / 1,0 kg / 22 l



040 black

066 red earth

**1578 HIKE PACK 24** RAINCOVER NEW

Microrip 2.1 / 60 x 26 x 16 cm / 1,02 kg / 24 l



040 black

066 red earth





## 1392 NORIX 24 WOMEN

RAINCOVER

Microrip 2.1 / 210 HD Nylon FD / 57 x 25 x 14 cm / 1,05 kg / 24 l



037 midnight plum



123 nougat

## 1393 NORIX 31 WOMEN

RAINCOVER

Microrip 2.1 / 210 HD Nylon FD / 62 x 26 x 15 cm / 1,15 kg / 31 l



021 titan grey



286 sage green

## 1394 NORIX 27

RAINCOVER

Microrip 2.1 / 210 HD Nylon FD / 58 x 25 x 15 cm / 1,10 kg / 27 l



021 titan grey



123 nougat

## 1395 NORIX 34

RAINCOVER

Microrip 2.1 / 210 HD Nylon FD / 64 x 27 x 16 cm / 1,22 kg / 34 l



021 titan grey



066 red earth

VENT COMFORT-SYSTEM WOMEN

VENT COMFORT-SYSTEM



## 1565 COMMUTER ROLLTOP 20 WP

NEW

420 den Nylon TPU / 47 x 26,5 x 14,5 cm / 1,10 kg / 2 l

incl. Notebook Sleeve



040 black

274 darker blue

332 stone grey olive



VENT COMFORT-SYSTEM

## 1563 COMMUTER ROLLTOP 25 WP

NEW COLOR

420 den Nylon TPU / 48 x 33 x 15,5 cm / 1,20 kg / 25 l

incl. Notebook Sleeve



040 black

● 274 darker blue

332 stone grey olive

## 1564 COMMUTER ROLLTOP 30 WP

NEW COLOR

420 den Nylon TPU / 50 x 32 x 16,5 cm / 1,28 kg / 30 l

incl. Notebook Sleeve



040 black

● 274 darker blue

332 stone grey olive

## 1561 BIKE BACKPACK MTB 14

RAINCOVER

100 den Honeycomb Recycled / 420 HD Nylon FD / 940 g / 14 l



040 black

## 1562 BIKE BACKPACK MTB 28

RAINCOVER

100 den Honeycomb Recycled / 420 HD Nylon FD / 53 x 29 x 19 cm / 1,27 kg / 28 l



040 black

VENT COMFORT-SYSTEM

## 1757 BIKE HIP BAG MTB 5

100 den Honeycomb Recycled / 420 HD Nylon FD / 20 x 26 x 7 cm / 380 g / 5 l



040 black

FRAME VENT-SYSTEM

## 1895 FRAME POUCH WP 40

420 den Nylon TPU / Taped / 40 x 14,5 x 7 cm / 150 g / 4 l



040 black

## 1896 FRAME POUCH WP 50

420 den Nylon TPU / Taped / 51 x 14,5 x 7 cm / 175 g / 6 l



040 black

## 1916 SADDLE STUFFBAG HOLDER

X-Pac® RX-30 / 420 HD Nylon Reflective / 39 x 18 x 18 cm / 485 g / 13 l



040 black

## 1898 STEM POUCH

X-Pac® RX-30 / 210 HD Nylon FD / 21 x 10 x 10 cm / 126 g / 1 l



040 black

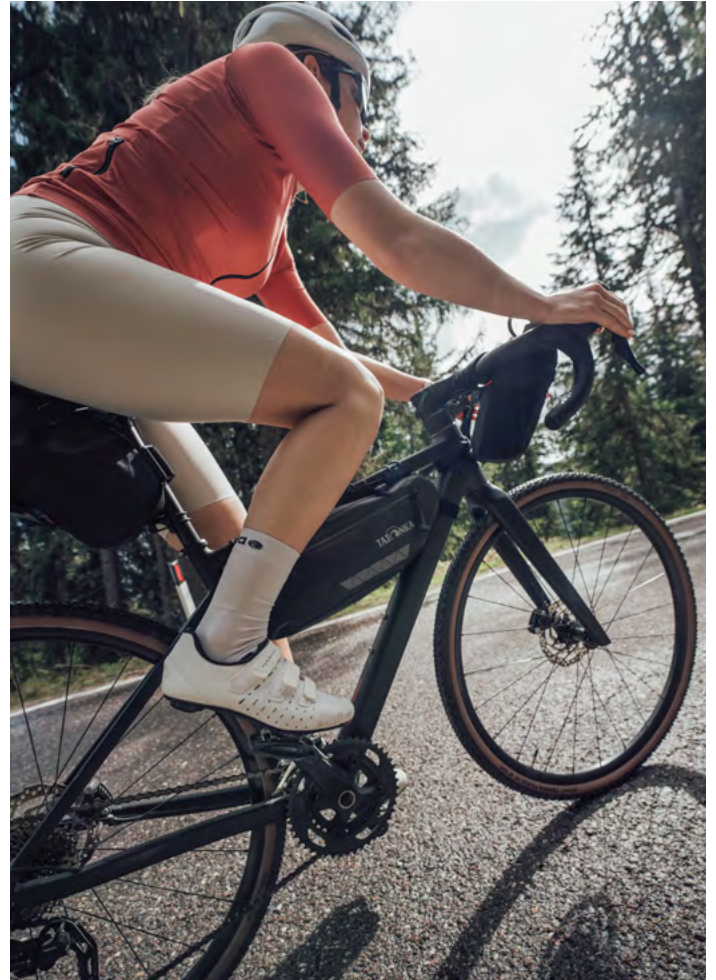

## 1903 BIKE SADDLE BAG S

X-Pac® RX-30 / 420 HD Nylon Reflective / 22 x 12 x 8 cm / 135 g / 0,5 l



FIDLOCK.



040 black

## 1904 BIKE SADDLE BAG M

X-Pac® RX-30 / 420 HD Nylon Reflective / 20 x 13 x 11 cm / 170 g / 1 l



FIDLOCK.



040 black

## 2802 BIKE PONCHO

Tex Cover Recycled / S, M, L / Ø 11 x 16 cm / 290 g



040 black

551 safety yellow

## 2753 HELMET COVER

Tex Cover Recycled / versiegelt / taped / 10 x 8,5 x 2 cm / 26 g / VE:5



551 safety yellow

## 2754 PANTS PROTECTOR

Hypalon / 18 x 15 mm / 40 g / VE:5

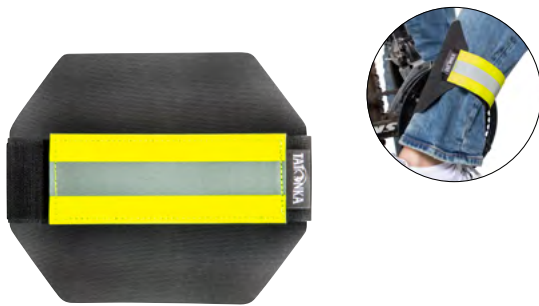

040 black

## 2743 VELO GAITER

Oxford 200 Recycled / S, M, L / Ø 30 x 40 cm / 125 g / (size L)



015 red

040 black

## 2752 SADDLE COVER

Tex Cover Recycled / 20 g / VE:5



551 safety yellow

## 2758 RAINCOVER BIKE DAYPACK

Tex Cover Recycled / 65 g



551 safety yellow





## 1575 ACTIVE PACK 9 WOMEN

Microrip 2.1 / 210 HD Nylon FD / 42 x 22 x 11 cm / 460 g / 9 l



037 midnight plum

040 black

279 elemental blue

## 1576 ACTIVE PACK 14 WOMEN

Microrip 2.1 / 210 HD Nylon FD / 43 x 23 x 14 cm / 470 g / 14 l



037 midnight plum

040 black

279 elemental blue

## 1573 ACTIVE PACK 10

Microrip 2.1 / 210 HD Nylon FD / 44 x 23 x 11 cm / 485 g / 10 l



040 black

279 elemental blue

286 sage green

## 1574 ACTIVE PACK 15

Microrip 2.1 / 210 HD Nylon FD / 45 x 23 x 14 cm / 510 g / 15 l



040 black

279 elemental blue

286 sage green

## 1591 ALL WEATHER PACK 20 WP NEW

CORDURA® 500 den / 420 HD Nylon FD / 50 x 33 x 13 cm / 860 g / 20 l

incl. Notebook Sleeve



040 black

332 stone grey olive

## 1592 ALL WEATHER PACK 25 WP NEW

CORDURA® 500 den / 420 HD Nylon FD / 52 x 34 x 13 cm / 950 g / 25 l

incl. Notebook Sleeve



040 black

332 stone grey olive



PADDED BACK-SYSTEM WOMEN

PADDED BACK-SYSTEM

### 1589 TOUGH PACK 25

NEW

N 1680 Ballistic PU / Textreme 6.6 Recycled / 49 x 30 x 16 cm / 1,0 kg / 25 l

incl. Notebook Sleeve



037 midnight plum



040 black

### 1590 TOUGH PACK 30

NEW

N 1680 Ballistic PU / Textreme 6.6 Recycled / 53 x 32 x 18 cm / 1,2 kg / 30 l

incl. Notebook Sleeve



037 midnight plum



040 black

### 1722 TOUGH SLING 8

NEW

N 1680 Ballistic PU / 41 x 22 x 12 cm / 500 g / 8 l

incl. Notebook Sleeve



037 midnight plum



040 black

---

---

---

---

---

---

---

---

---

---



## 1646 CITY PACK 15

Textreme 6.6 Recycled / Microrip 2.1 / 42 x 24 x 12 cm / 370 g / 15 l



004 navy

021 titan grey

037 midnight plum

## 1649 CITY PACK 15 KAPOK

Textreme 6.6 Kapok Recycled / Textreme 6.6 Recycled / 42 x 24 x 12 cm / 400 g / 15 l



040 black

187 brown rice

286 sage green

## 1647 CITY PACK 20

Textreme 6.6 Recycled / Microrip 2.1 / 49 x 29 x 12 cm / 470 g / 20 l



004 navy

021 titan grey

037 midnight plum

## 1650 CITY PACK 20 KAPOK

Textreme 6.6 Kapok Recycled / Textreme 6.6 Recycled / 49 x 29 x 12 cm / 485 g / 20 l



040 black

187 brown rice

286 sage green

## 1648 CITY PACK 22

Textreme 6.6 Recycled / Microrip 2.1 / 51 x 30 x 15 cm / 675 g / 22 l



004 navy

021 titan grey

## 1651 CITY PACK 22 KAPOK

Textreme 6.6 Kapok Recycled / Textreme 6.6 Recycled / 51 x 30 x 15 cm / 710 g / 22 l



040 black

286 sage green

## 1652 HIP SLING PACK 5

Textreme 6.6 Recycled / Microrip 2.1 / 34 x 19,5 x 6,5 cm / 240 g / 5 l



004 navy

021 titan grey

037 midnight plum

## 1653 HIP SLING PACK 5 KAPOK

Textreme 6.6 Kapok Recycled / Textreme 6.6 Recycled / 34 x 19,5 x 6,5 cm / 240 g / 5 l



040 black

187 brown rice

286 sage green

PADDED BACK-SYSTEM

THERMO MOLD-SYSTEM

### 1654 GRIP ROLLTOP PACK 25

CORDURA® 500 den / Microrip 2.1 / 50 x 28 x 13 cm / 560 g / 25 l



004 navy      021 titan grey      037 midnight plum

### 1655 GRIP ROLLTOP PACK 25 KAPOK

Textreme 6.6 Kapok Recycled / CORDURA® 500 den / 50 x 28 x 13 cm / 590 g / 25 l



040 black      187 brown rice      286 sage green

### 1656 GRIP ROLLTOP PACK 34

CORDURA® 500 den / Microrip 2.1 / 55 x 32 x 17 cm / 620 g / 34 l



004 navy      021 titan grey      037 midnight plum

### 1657 GRIP ROLLTOP PACK 34 KAPOK

Textreme 6.6 Kapok Recycled / CORDURA® 500 den / 55 x 32 x 17 cm / 710 g / 34 l



040 black      187 brown rice      286 sage green

### 2216 SUPERLIGHT

Tex Cover Recycled / 420 HD Nylon FD / 43 x 32 x 14 cm / 190 g / 18 l



040 black

### 1658 GRIP BAG

CORDURA® 500 den / 41 x 32 x 10 cm / 440 g / 13 l



004 navy      021 titan grey      037 midnight plum

### 1659 GRIP BAG KAPOK

Textreme 6.6 Kapok Recycled / CORDURA® 500 den / 41 x 32 x 10 cm / 460 g / 13 l



040 black      187 brown rice      286 sage green



## 1723 TOUGH BAG M

NEW

N 1680 Ballistic PU / Textreme 6.6 Recycled / 40 x 30 x 11 cm / 970 g / 16 l

incl. Notebook Sleeve

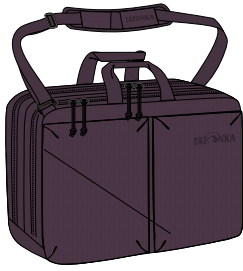

037 midnight plum



040 black

## 1724 TOUGH BAG L

NEW

N 1680 Ballistic PU / Textreme 6.6 Recycled / 43 x 33 x 18 cm / 1,2 kg / 25 l

incl. Notebook Sleeve



037 midnight plum



040 black

## 2839 CROSS BODY BAG S

X-Pac® RX-30 / 420 HD Nylon FD / 20 x 25 x 2 cm / 125 g / 2 l



040 black



279 elemental blue



286 sage green

## 2840 CROSS BODY BAG M

X-Pac® RX-30 / 420 HD Nylon FD / 20 x 27 x 6 cm / 260 g / 3 l



040 black



279 elemental blue



286 sage green

## 2841 CROSS BODY BAG L

X-Pac® RX-30 / 420 HD Nylon FD / 22 x 30 x 6 cm / 290 g / 4 l



040 black



279 elemental blue



286 sage green

## 2842 CROSS BODY BAG XL

X-Pac® RX-30 / 420 HD Nylon FD / 26 x 32 x 10 cm / 550 g / 12 l



040 black



279 elemental blue



286 sage green

## 2219 MARKET BAG

Oxford 200 Recycled / 41 x 31 x 16 cm / 300 g / 22 l



040 black



066 red earth



SEAT PAD

### 1778 HUSKY BAG 10 JR

SEAT PAD

Textreme 6.6 Recycled / 100 den Honeycomb Recycled / 32 x 22 x 10 cm / 275 g / 10 l



004 navy



037 midnight plum



286 sage green

### 1779 CITY PACK JR 12

SEAT PAD

Textreme 6.6 Recycled / 100 den Honeycomb Recycled / 40 x 24 x 12 cm / 390 g / 12 l



004 navy



037 midnight plum



286 sage green

### 1780 ROLLTOP PACK JR 14

SEAT PAD

Textreme 6.6 Recycled / 100 den Honeycomb Recycled / 42 x 23 x 15 cm / 420 g / 14 l



004 navy



037 midnight plum



286 sage green

### 1781 WOKIN 15

SEAT PAD

Textreme 6.6 Recycled / 100 den Honeycomb Recycled / 46 x 23 x 14 cm / 470 g / 15 l



004 navy



037 midnight plum



286 sage green

### 1782 MANI 20

SEAT PAD

Textreme 6.6 Recycled / 100 den Honeycomb Recycled / 48 x 24 x 16 cm / 575 g / 20 l



004 navy



037 midnight plum



286 sage green

### 1783 YUKON 32 JR

Textreme 6.6 Recycled / 100 den Honeycomb Recycled / 59 x 26 x 17 cm / 1,33 kg / 32 l



004 navy



286 sage green

Blank lines for notes or specifications.



FRAME COMFORT LIGHT-SYSTEM WOMEN

### 1142 GREAT ESCAPE 50+15 WOMEN

Textreme 6.6 Recycled / Microrip 2.1 / 59 x 29 x 24 cm / 2,24 kg / 65 l



040 black



286 sage green

### 1141 GREAT ESCAPE 60+15

Textreme 6.6 Recycled / Microrip 2.1 / 64 x 31 x 27 cm / 2,25 kg / 75 l



040 black



286 sage green

FRAME COMFORT LIGHT-SYSTEM

### 1143 GREAT ESCAPE 70+15 NEW

Textreme 6.6 Recycled / Microrip 2.1 / 69 x 30 x 27 cm / 2,52 kg / 85 l



040 black

### 1153 FLIGHTCASE 27

Textreme 6.6 Recycled / Travel Tex Melange / 52 x 28 x 16 cm / 1,10 kg / 27 l



040 black



286 sage green

PADDED BACK-SYSTEM

### 1152 FLIGHTCASE 40

Textreme 6.6 Recycled / Travel Tex Melange / 55 x 32 x 18 cm / 1,43 kg / 40 l



040 black



286 sage green

### 1937 TRAVELLER PACK 35

Travel Tex Melange / 420 HD Nylon FD / 53 x 31 x 22 cm / 1,30 kg / 35 l



020 navy blue

040 black

286 sage green

376 tango red

PADDED BACK-SYSTEM

### 1936 DUFFLE BAG 45

Travel Tex Melange / 420 HD Nylon FD / 57 x 30 x 24 cm / 840 g / 45 l



020 navy blue



040 black



286 sage green



376 tango red

### 1935 DUFFLE BAG 65

Travel Tex Melange / 420 HD Nylon FD / 65 x 32 x 32 cm / 1,00 kg / 65 l



020 navy blue



040 black



286 sage green



376 tango red

FRAME COMFORT LIGHT-SYSTEM

PADDED BACK-SYSTEM

THERMO MOLD AIRMESH-SYSTEM

## 1977 DUFFLE ROLLER 80

Travel Tex Melange / 420 HD Nylon FD / 78 x 32 x 25 cm / 1,96 kg / 80 l



020 navy blue    040 black    286 sage green    376 tango red

## 1959 DUFFLE ROLLER 105

Travel Tex Melange / 420 HD Nylon FD / 84 x 34 x 30 cm / 2,20 kg / 105 l



020 navy blue    040 black    286 sage green    376 tango red

## 1964 DUFFLE ROLLER 140

Travel Tex Melange / 420 HD Nylon FD / 87 x 40 x 33 cm / 2,44 kg / 140 l



020 navy blue    040 black    286 sage green    376 tango red

## 1967 TRAVEL ROLLER 40

Travel Tex Melange / Textreme 6.6 Recycled / 50 x 32 x 19 cm / 2,72 kg / 40 l



040 black    286 sage green

## 1968 TRAVEL ROLLER 60

Travel Tex Melange / Textreme 6.6 Recycled / 67 x 37 x 27 cm / 3,33 kg / 60 l



040 black    286 sage green

## 1980 TRAVEL ROLLER 90

Travel Tex Melange / Textreme 6.6 Recycled / 75 x 40 x 28 cm / 3,66 kg / 90 l



040 black    286 sage green

## 1922 TOUGH DUFFLE 45

NEW

N 1680 Ballistic PU / Textreme 6.6 Recycled / 61 x 31 x 25 cm / 990 g / 45 l

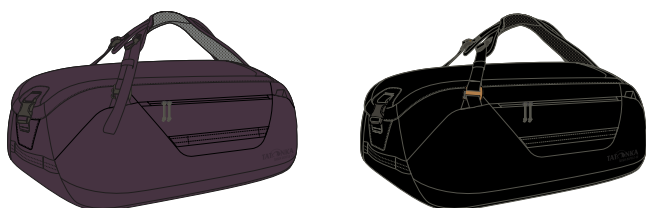

037 midnight plum    040 black

## 1925 TOUGH DUFFLE 65

NEW

N 1680 Ballistic PU / Textreme 6.6 Recycled / 70 x 36 x 29 cm / 1,20 kg / 65 l

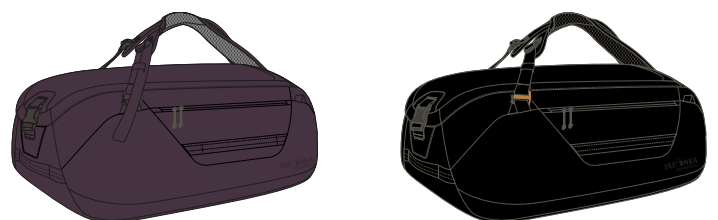

037 midnight plum    040 black

## 1971 BARREL 25

Travel Ballistic TPU / 420 HD Nylon FD / 42 x 27 x 27 cm / 990 g / 25 l



040 black



135 apricot



279 elemental blue

## 1972 BARREL 45

Travel Ballistic TPU / 420 HD Nylon FD / 53 x 33 x 33 cm / 1,33 kg / 45 l



040 black



135 apricot



279 elemental blue

## 1973 BARREL 65

Travel Ballistic TPU / 420 HD Nylon FD / 61 x 38 x 38 cm / 1,50 kg / 65 l



040 black



211 red orange



279 elemental blue



286 sage green

## 1974 BARREL 85

Travel Ballistic TPU / 420 HD Nylon FD / 69 x 42 x 42 cm / 1,83 kg / 85 l



040 black



211 red orange



279 elemental blue



286 sage green

## 1975 BARREL 110

Travel Ballistic TPU / 420 HD Nylon FD / 74 x 44 x 44 cm / 2,00 kg / 110 l



040 black



211 red orange



279 elemental blue

## 1976 BARREL 130

Travel Ballistic TPU / 420 HD Nylon FD / 85 x 52 x 52 cm / 2,35 kg / 130 l



040 black



279 elemental blue

## 1969 FLIGHT BARREL

Travel Ballistic TPU / 420 HD Nylon FD / 50 x 36 x 20 cm / 1,22 kg / 35 l



040 black



279 elemental blue



286 sage green

## 1956 BARREL ROLLER 60

Travel Ballistic TPU / 420 HD Nylon FD / 59 x 35 x 35 cm / 3,58 kg / 60 l



040 black



279 elemental blue

## 1957 BARREL ROLLER 80

Travel Ballistic TPU / 420 HD Nylon FD / 72 x 42 x 35 cm / 4,50 kg / 80 l



040 black



286 sage green

## 1966 FLIGHT ROLLER 135

Travel Ballistic TPU / 420 HD Nylon FD / 98 x 40 x 33 cm / 4,17 kg / 135 l



040 black



## 1946 GEAR BAG 40

Textreme 6.6 Recycled / 45 x 25 x 35 cm / 625 g / 40 l



040 black

## 1949 GEAR BAG 80

Textreme 6.6 Recycled / 50 x 45 x 35 cm / 865 g / 80 l



040 black

## 1940 GEAR BAG 100

Textreme 6.6 Recycled / 90 x 30 x 35 cm / 1,05 kg / 100 l



040 black

### 3177 SQZY COMPRESSION POUCH A4

NEW

Light Tex / 21 x 30 x 12 cm / 66 g / 8 l



004 navy



049 ash grey

### 3178 SQZY COMPRESSION POUCH A3

NEW

Light Tex / 30 x 42 x 12 cm / 92 g / 15 l



066 red earth



286 sage green

### 3179 SQZY COMPRESSION POUCH SET (2XA4/1XA3)

NEW

Light Tex / 224 g / 31 l

assorted



3178

3177

3177

### 3180 SQZY SMART PACKER SET 1

NEW

Light Tex / 168 g / 12,2 l

assorted



3177

3183

3176

### 3181 SQZY SMART PACKER SET 2

NEW

Light Tex / 260 g / 27,2 l

assorted



3178

3177

3176

3183

### 3175 SQZY PADDED POUCH A6

NEW

Light Tex / 15 x 10,5 x 8 cm / 48 g / 0,5 l



066 red earth



286 sage green

### 3176 SQZY PADDED POUCH A5

NEW

Light Tex / 21 x 15 x 8 cm / 72 g / 1,7 l



004 navy



049 ash grey

## SQZY STUFF BAG

NEW

Light Tex



3062 SQZY Stuff Bag 0,5l	13 x 8 x 5 cm / 0,5 l / 10 g	066 red earth	286 sage green
3063 SQZY Stuff Bag 2l	23 x 12 x 7 cm / 2 l / 20 g	004 navy	049 ash grey
3064 SQZY Stuff Bag 5l	30 x 17,5 x 10 cm / 5 l / 25 g	066 red earth	286 sage green
3066 SQZY Stuff Bag 10l	38 x 24 x 13 cm / 10 l / 35 g	004 navy	049 ash grey

## 3058 SQZY STUFF BAG SET (2L/5L/10L) NEW

Light Tex / 80 g



001 assorted

## SQZY DRY BAG

NEW

Light Tex



3088 SQZY Dry Bag 5l	32 x 18 x 10 cm / 5 l / 26 g	066 red earth	286 sage green
3089 SQZY Dry Bag 10l	40 x 24 x 14 cm / 10 l / 36 g	004 navy	049 ash grey
3091 SQZY Dry Bag 15l	44 x 26 x 15 cm / 15 l / 42 g	066 red earth	286 sage green
3092 SQZY Dry Bag 20l	50 x 29 x 16 cm / 20 l / 52 g	004 navy	049 ash grey

## 3093 SQZY DRY BAG SET NEW

NEW

Light Tex / 104 g / 5 l / 10 l / 15 l



001 assorted

## SQZY POUCH

NEW

Light Tex



3182 SQZY Pouch A6	15,5 x 11 x 8 cm / 1 l / 24 g	004 navy	049 ash grey
3183 SQZY Pouch A5	21 x 15 x 8 cm / 2,5 l / 30 g	066 red earth	286 sage green
3184 SQZY Pouch A4	30 x 21 x 8 cm / 5 l / 44 g	004 navy	049 ash grey
3185 SQZY Pouch A3	42 x 29,5 x 8 cm / 10 l / 62 g	066 red earth	286 sage green



## 3186 SQZY POUCH SET 1 (2XA5/1XA4) NEW

NEW

Light Tex / 104 g



001 assorted

## 3187 SQZY POUCH SET 2 (2XA4/1XA3) NEW

NEW

Light Tex / 152 g



001 assorted

## 2768 SMALL TRAVELCARE

Textreme 6.6 Recycled / 15 x 27 x 4 cm / 150 g



004 navy      021 titan grey      037 midnight plum  
066 red earth      286 sage green

## 2769 TRAVELCARE

Textreme 6.6 Recycled / 17 x 34 x 4 cm / 190 g



004 navy      021 titan grey      037 midnight plum  
066 red earth      286 sage green

## 2770 ONE DAY

Textreme 6.6 Recycled / 21 x 12,5 x 6 cm / 80 g / 1,5 l



004 navy      021 titan grey      037 midnight plum  
066 red earth      286 sage green

## 2771 CARE BARREL

Textreme 6.6 Recycled / 26 x 14 x 14 cm / 160 g / 3 l



004 navy      021 titan grey      037 midnight plum  
066 red earth      286 sage green

## 2791 SQUARE ZIP POUCH S

Travel Tex Melange / 8 x 19 x 7 cm / 108 g / 1 l



020 navy blue      040 black      286 sage green      376 tango red

## 2792 SQUARE ZIP POUCH M

Travel Tex Melange / 10 x 25 x 9 cm / 154 g / 2 l



020 navy blue      040 black      286 sage green      376 tango red

## 2790 COSMETIC DOUBLE ZIP POUCH

Travel Tex Melange / 17 x 27 x 13 cm / 240 g / 6 l



020 navy blue      040 black      286 sage green      376 tango red

## 1339 HIP & BAR POUCH BC

CORDURA® 500 den / 24 x 16 x 8 cm / 320 g / 3 l



040 black



332 stone grey olive

## 2226 HIP BOTTLE DOUBLE II

100 den Honeycomb Recycled / 420 HD Nylon FD / 26 x 19 x 9 cm / 280 g / 3 l



040 black



279 elemental blue

## 2223 HIP BAG M

100 den Honeycomb Recycled / 420 HD Nylon FD / 18 x 26 x 10 cm / 170 g / 3 l



040 black



279 elemental blue

## 2224 HIP BAG L

100 den Honeycomb Recycled / 420 HD Nylon FD / 32 x 19,5 x 12,5 cm / 220 g / 5 l



040 black



279 elemental blue

## 2210 FUNNY BAG "S"

Textreme 6.6 Recycled / 32 x 16 x 6 cm / 110 g



021 titan grey



040 black



279 elemental blue

## 2215 FUNNY BAG "M"

Textreme 6.6 Recycled / 34 x 12 x 9 cm / 150 g



021 titan grey



040 black



279 elemental blue

## 2211 ILIUM S

T-Microrip 2.1 Eco, 210 HD Nylon FD Eco / 95 g



021 titan grey



040 black



279 elemental blue

## 2212 ILIUM M

Microrip 2.1 / 210 HD Nylon FD / 35 x 14 x 10 cm / 120 g



021 titan grey



040 black



279 elemental blue

## 2213 ILIUM L

Microrip 2.1 / 210 HD Nylon FD / 37 x 16 x 10 cm / 150 g



021 titan grey



040 black



279 elemental blue



## 2928 WP NECK POUCH

70 den Nylon TPU / HF welding / 21 x 14 cm / 30 g / VE:3



040 black

252 lime

## 2929 WP ID POCKET

70 den Nylon TPU / HF welding / 12 x 15 cm / 25 g / VE:3



040 black

252 lime

## 2937 WP CHEST HOLSTER

70 den Nylon TPU / 20,5 x 16 cm / 50 g / VE:3



040 black

252 lime

## 3096 WP ZIP NECK POUCH M

420 den Nylon TPU / HF welding / 27,5 x 18 cm / 55 g / VE:3



040 black

252 lime

## 3097 WP ZIP NECK POUCH L

420 den Nylon TPU / HF welding / 32 x 20 cm / 60 g / VE:3



040 black

252 lime

## 2838 SOFT ID POCKET

Soft Touch Spandex / 9 x 12 cm / 15 g / VE:3



213 nude

## 2834 SOFT BRA POCKET

Soft Touch Spandex / 10 x 7 cm / 10 g / VE:3



213 nude

## 2851 SKIN MONEYBELT

65/35 Polycotton Melange / 12 x 33 cm / 25 g / VE:12



331 olive

434 macchiato

701 dark blue

## 2853 SKIN NECK POUCH

65/35 Polycotton Melange / 19 x 13 cm / 20 g / VE:12



331 olive

434 macchiato

701 dark blue

## 2965 SKIN ID POUCH

65/35 Polycotton Melange / 11 x 12 cm / 12 g / VE:12



331 olive

434 macchiato

701 dark blue

## 2844 SKIN ID POCKET

Square Rip Light / 10 x 13 cm / 20 g / VE:3



040 black



225 natural



040 black



225 natural



040 black



225 natural

## 2846 SKIN DOCUMENT BELT

Square Rip Light / 12 x 23 cm / 40 g / VE:3



040 black



225 natural



040 black



225 natural

## 2848 SKIN MONEYBELT INT.

Square Rip Light / 14 x 28 cm / 50 g / VE:3



040 black



225 natural

## 2860 SKIN WAIST POUCH

Square Rip Light / 13 x 33 cm / 80 g / VE:3



040 black



225 natural

## 2855 SKIN WRIST WALLET

Square Rip Light / 26 x 8 cm / 30 g / VE:3



040 black



225 natural

## 2859 SKIN CHEST HOLSTER

Square Rip Light / 19 x 19 cm / 55 g / VE:3



040 black



225 natural

## 2854 SKIN SECRET POCKET

Square Rip Light / 19 x 19 cm / 40 g / VE:3



040 black



225 natural

## 2861 FLIP IN POCKET

Square Rip Light / 12,5 x 19 x 1 cm / 25 g / VE:3



040 black



225 natural

## 2902 SKIN ID POCKET RFID BLOCK

Square Rip Light / CRYPTALLOY® / 10 x 13 cm / 25 g / VE:3



040 black



225 natural

## 2959 SKIN NECK POUCH RFID BLOCK

Square Rip Light / CRYPTALLOY® / 19 x 13 cm / 40 g / VE:3



040 black



225 natural

## 2947 SKIN MONEYBELT INT. RFID BLOCK

Square Rip Light / CRYPTALLOY® / 14 x 28 cm / 55 g / VE:3



040 black



225 natural

## 2961 SKIN CHEST HOLSTER RFID BLOCK

Square Rip Light / CRYPTALLOY® / 19 x 19 cm / 80 g / VE:3



040 black



225 natural

### 3161 MONEY BOX RFID BLOCK

Textreme 6.6 Recycled / CRYPTALLOY® / 9 x 13 x 1 cm / 50 g / VE:3



037 midnight plum



040 black



331 olive

### 3162 FOLDER RFID BLOCK

Textreme 6.6 Recycled / CRYPTALLOY® / 9 x 12 x 2 cm / 65 g / VE:3



037 midnight plum



040 black



331 olive

### 3163 EURO WALLET RFID BLOCK

Textreme 6.6 Recycled / CRYPTALLOY® / 10 x 14 x 2 cm / 80 g / VE:3



037 midnight plum



040 black



331 olive

### 3164 ZIP MONEY BOX RFID BLOCK

Textreme 6.6 Recycled / CRYPTALLOY® / 9 x 11 x 2 cm / 62 g / VE:3



037 midnight plum



040 black



331 olive

### 2885 ID WALLET RFID B

Textreme 6.6 Recycled / CRYPTALLOY® / 14,5 x 9,5 x 1 cm / 74 g / VE:3



037 midnight plum



040 black



331 olive

**Without RFID block  
DATA THEFT IS POSSIBLE**

Documents, cards and devices equipped with RFID chips and devices can be read.

### 3165 PLAIN WALLET RFID BLOCK

Textreme 6.6 Recycled / CRYPTALLOY® / 11 x 7 x 2 cm / 50 g / VE:3



037 midnight plum



040 black



331 olive

### 3166 BIG PLAIN WALLET RFID BLOCK

Textreme 6.6 Recycled / CRYPTALLOY® / 13 x 9 x 2 cm / 68 g / VE:3



037 midnight plum



040 black



331 olive

## 3167 PASSPORT SAFE RFID BLOCK

Textreme 6.6 Recycled / CRYPTALLOY® / 10,5 x 14,5 x 1 cm / 48 g / VE:3



037 midnight plum



040 black



331 olive

## 3168 TRAVEL ZIP M RFID BLOCK

Textreme 6.6 Recycled / CRYPTALLOY® / 17 x 12 x 3 cm / 92 g / VE:3



037 midnight plum



040 black



331 olive

## 3169 SLEEVE RFID BLOCK SET

210 HD Nylon FD / CRYPTALLOY® / 9 x 6,5 cm / 8 g / VE:3



001 assorted

## 3170 CARD HOLDER RFID BLOCK

210 HD Nylon FD / CRYPTALLOY® / 9,5 x 6 cm / 18 g / VE:3



037 midnight plum



040 black



331 olive

**With RFID block  
SAFE FROM DATA THEFT**

The RFID Block products from Tatonka prevent the unauthorized reading of personal data.

## 3171 HANG LOOSE RFID BLOCK

Textreme 6.6 Recycled / CRYPTALLOY® / 20 x 14 x 2 cm / 95 g / VE:3



037 midnight plum



040 black



331 olive

## 3172 CHECK IN RFID BLOCK

Textreme 6.6 Recycled / CRYPTALLOY® / 21 x 15 x 7 cm / 192 g / VE:3



037 midnight plum



040 black



331 olive

## 3173 CHECK IN XL RFID BLOCK

Textreme 6.6 Recycled / CRYPTALLOY® / 27,5 x 20,5 x 9 cm / 305 g / VE:3



037 midnight plum



040 black



331 olive

## 2868 STRETCHBELT 38 BC

Spandex Webbing / 105 x 3,8 cm / 145 g / VE:3



040 black



332 stone grey olive

## 2865 STRETCH BELT 25MM

Spandex Webbing / 110 x 2,5 cm / 60 g / VE:3



040 black



048 warm grey

## 2867 STRETCH BELT 32MM

Spandex Webbing / 125 x 3,2 cm / 80 g / VE:3



040 black



346 coyote brown

## 2870 STRETCHBELT 38MM

Spandex Webbing / 125 x 3,8 cm / 95 g / VE:3



040 black



332 stone grey olive

## 2863 TRAVEL WAISTBELT 30MM

Polyester Webbing Recycled / 130 x 3 cm / 100 g / VE:3

NEW COLOR



- 021 titan grey
- 279 elemental blue
- 123 nougat
- 331 olive
- 040 black
- 066 red earth



## 2864 TRAVEL BELT 32MM

Polyester Webbing Recycled / 149 x 3,2 cm / 95 g / VE:3

NEW COLOR



040 black

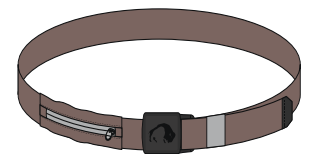

● 123 nougat



## CAPE

Tex Cover Recycled / versiegelt / taped

2794 Cape XS	Ø 11 x 20 cm / 330 g	015 red	036 cub
2795 CAPE S	Ø 11 x 25 cm / 360 g	015 red	036 cub
2796 CAPE M	Ø 11 x 25 cm / 380 g	015 red	036 cub
2797 CAPE L	Ø 11 x 25 cm / 420 g	015 red	036 cub
2798 CAPE XL	Ø 11 x 25 cm / 430 g	015 red	036 cub



## PONCHO

2799 PONCHO 1 (XS-S)	Ø 11 x 16 cm / 265 g	015 red	036 cub
2800 PONCHO 2 (M-L)	Ø 11 x 16 cm / 315 g	015 red	036 cub
2801 PONCHO 3 (XL-XXL)	Ø 11 x 18 cm / 350 g	015 red	036 cub



## 2745 GAITER 500 CORDURA BC

CORDURA® 500 den / M, L / Ø 41 x 42 cm / 220 g / (size M, size L 240g)



332 stone grey olive

## 2750 GAITER 420 HD

420 HD Nylon FD / M, L / Ø 41 x 42 cm / 220 g / (size M, size L 240g)



015 red

040 black

331 olive

## 2749 GAITER 420 HD SHORT

420 HD Nylon FD / Ø 40 x 25 cm / 150 g



015 red

040 black

331 olive

## 2751 GAITER 420 HD JUNIOR

420 HD Nylon FD / Ø 35 x 35 cm / 180 g



015 red

040 black

## 2746 GAITER RIPSTOP SHORT LIGHT

Square Rip Light / Ø 49 x 29 cm / 120 g



040 black

## 2747 GAITER 210 HD SHORT LIGHT

Oxford 200 Recycled / Ø 49 x 29 cm / 95 g



040 black





### 2730 FIRST AID PACK

420 HD Nylon FD / 45 x 37 x 22 cm / 650 g / 20 l

### 2720 FIRST AID FAMILY

420 HD Nylon FD / 25 x 18 x 18 cm / 390 g / 7 l



015 red



015 red

### 2807 FIRST AID "XS"

420 HD Nylon FD / 10 x 7 x 4 cm / 35 g / VE:3

### 2810 FIRST AID "S"

420 HD Nylon FD / 18 x 12,5 x 5,5 cm / 140 g / VE:3

### 2815 FIRST AID "M"

420 HD Nylon FD / 26 x 13,5 x 8 cm / 200 g / VE:3



015 red

040 black



015 red

040 black



015 red

040 black

### 2985 RETTUNGSDECKE

Aluminium coated PE-foil / 210 x 160 cm / 60 g / VE:10



028 gold

### 2690 FIRST AID SCHOOL

NEW

210 HD Nylon FD / 10 x 8 x 4 cm / 70 g / VE:3



015 red

### 2691 FIRST AID MINI

NEW

210 HD Nylon FD / 10 x 8 x 4 cm / 85 g / VE:3



015 red



040 black



All products with this symbol  are filled and were designed in collaboration with the "Outdoorschule Süd"



Medical Devices and Kit Filling – First Aid with Over 100 Years of Experience



## 2692 FIRST AID BASIC

NEW

210 HD Nylon FD / 14,5 x 11 x 5 cm / 220 g



015 red



## 2693 FIRST AID BASIC WATERPROOF

NEW

Tex Cover Recycled / versiegelt / taped / 20 x 13 x 5 cm / 225 g



015 red



## 2696 FIRST AID COMPACT

NEW

210 HD Nylon FD / 17,5 x 12 x 5,5 cm / 395 g



015 red



## 2698 FIRST AID COMPLETE

NEW

210 HD Nylon FD / 18 x 14 x 8 cm / 515 g



015 red



## 2699 FIRST AID ADVANCED

NEW

210 HD Nylon FD / 25 x 18 x 9 cm / 760 g



015 red



## RAIN FLAP

Tex Cover Recycled

XXS



XS



S



M



L



XL



XXL



3106 RAIN FLAP "XXS"

10-22l / Ø 9 x 9 cm / 80 g

316 spring

3107 RAIN FLAP "XS"

20-30l Ø 9 x 9 cm / 80 g

015 red

036 cub

3108 RAIN FLAP "S"

30-40l Ø 9 x 9 cm / 100 g

015 red

036 cub

3109 RAIN FLAP "M"

40-55l Ø 9 x 10 cm / 120 g

015 red

036 cub

3110 RAIN FLAP "L"

55-70l Ø 9 x 10 cm / 140 g

015 red

036 cub

3111 RAIN FLAP "XL"

70-80l Ø 9 x 12 cm / 150 g

015 red

036 cub

3112 RAIN FLAP "XXL"

80-100l Ø 9 x 12 cm / 170 g

015 red

036 cub

## RAIN COVER

Tex Cover Recycled

20-30 l



30-40 l



40-50 l



55-70 l



70-90 l



3114 RAIN COVER 20-30L

20-30l / Ø 8 x 10 cm / 65 g

040 black

211 red orange

332 stone grey olive

3116 RAIN COVER 30-40L

30-40l / Ø 8 x 11 cm / 85 g

040 black

211 red orange

332 stone grey olive

3117 RAIN COVER 40-55L

40-55l / Ø 8 x 12 cm / 120 g

040 black

211 red orange

332 stone grey olive

3118 RAIN COVER 55-70L

55-70l / Ø 8 x 14 cm / 130 g

040 black

211 red orange

332 stone grey olive

3119 RAIN COVER 70-90L

70-90l / Ø 8 x 16 cm / 150 g

040 black

211 red orange

332 stone grey olive

### 3084 SCHUTZSACK UNIVERSAL

Oxford 200 Recycled / 100 x 40 x 29 cm / 200 g / 85 l / VE:5



040 black

### 3095 SCHUTZSACK EINFACH

Reinforced PE-Foil / 148 x 70 cm / 215 g / 85 l / VE:10



### 3085 SCHUTZSACK "M"

420 HD Nylon FD / 84 x 40 x 25 cm / 450 g / 70 l / VE:5



040 black

### 3090 SCHUTZSACK "L"

420 HD Nylon FD / 99 x 51 x 30 cm / 650 g / 110 l / VE:5



040 black

### 3094 PACK COVER UNIVERSAL

Reinforced PE-Foil / 110 x 69 x 28 cm / 340 g / 130 l / VE:5



045 white



### 3270 CHEST BELT 20MM

Polyester Webbing Recycled / 50 x 2 cm / 30 g / VE:3



040 black

### 3271 CHEST BELT 25MM

Polyester Webbing Recycled / 50 x 2,5 cm / 40 g / VE:3



040 black

### 3272 HIP BELT 25 MM

Polyester Webbing Recycled / 110 x 2,5 cm / 50 g / VE:3



040 black

### 3273 HIP BELT 38 MM

Polyester Webbing Recycled / 110 x 3,8 cm / 80 g / VE:3



040 black



## 2016 NOTEBOOK SLEEVE

Textreme 6.6 Recycled / Microrip 2.1 / 39 x 27 x 4 cm / 235 g

Fits to: 1417 EDC Pack 30 BC, 1427 EDC Pack 23 BC



040 black

## 2015 EDC ORGANISATION SET

Microrip 2.1 / 315 g

Fits to: 1417 EDC Pack 30 BC, 1427 EDC Pack 23 BC



040 black

## 3301 SIDE POCKET 4L BC

CORDURA® 500 den / 28 x 19,5 x 8 cm / 185 g / 4 l



040 black



332 stone grey olive

## 3302 SIDE POCKET 8L BC

CORDURA® 500 den / 40 x 20 x 10 cm / 275 g / 8 l



040 black



332 stone grey olive

## 1416 CAPTURE POUCH WP BC

CORDURA® 500 den / versiegelt / taped / 20 x 21 x 10,5 cm / 260 g / 5 l



040 black

## 3265 CAMERA STRAP SET

Polyester Webbing Recycled / Microrip 2.1 / 120 x 3,8 cm / 105 g



040 black

## CAMERA INSERT

Textreme 6.6 Recycled

Fits to Backpacks ≤ 35 l / > 35 l



2919 CAMERA INSERT M 30 x 25 x 11 cm / 290 g 040 black

2920 CAMERA INSERT L 35 x 30 x 14 cm / 420 g 040 black

## LENS POCKET

Textreme 6.6 Recycled



2921 LENS POCKET S 12 x 9 x 9 cm / 65 g 040 black

2922 LENS POCKET M 17 x 10 x 10 cm / 90 g 040 black

### 2911 COOLER SHOULDERBAG 25 NEW COLOR

Travel Tex Melange / Textreme 6.6 Recycled / 37 x 27 x 30 cm / 595 g / 25 l



037 midnight plum



040 black

### 2825 COOLER BAG SIX PACK NEW COLOR

Travel Tex Melange / Textreme 6.6 Recycled / 30 x 29 x 19 cm / 615 g / 16 l



037 midnight plum



040 black

### 2913 COOLER BAG S NEW COLOR

Travel Tex Melange / Textreme 6.6 Recycled / 22 x 12 x 30 cm / 230 g / 6 l



037 midnight plum



040 black

### 2914 COOLER BAG M NEW COLOR

Travel Tex Melange / Textreme 6.6 Recycled / 32 x 16 x 36 cm / 325 g / 15 l



037 midnight plum



040 black

### 2915 COOLER BAG L NEW COLOR

Travel Tex Melange / Textreme 6.6 Recycled / 37 x 27 x 30 cm / 460 g / 25 l



037 midnight plum



040 black

### 3147 THERMO BOTTLE COVER 0,6L NEW

Textreme 6.6 Recycled / Ø 10 x 25 cm / 0,6 l / 68 g / VE:3

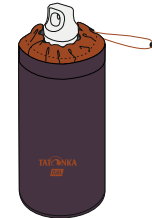

037 midnight plum



040 black

### 3151 THERMO BOTTLE COVER 0,75L NEW

Textreme 6.6 Recycled / Ø 10 x 28 cm / 0,75 l / 90 g / VE:3

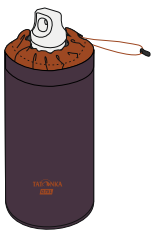

037 midnight plum

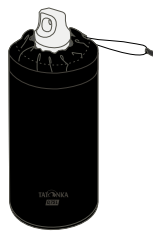

040 black

### 3148 THERMO BOTTLE COVER 1L NEW

Textreme 6.6 Recycled / Ø 11 x 29 cm / 1 l / 94 g / VE:3

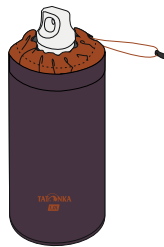

037 midnight plum



040 black

### 3149 THERMO BOTTLE COVER 1,5L NEW

Textreme 6.6 Recycled / Ø 12 x 33 cm / 1,5 l / 106 g / VE:3

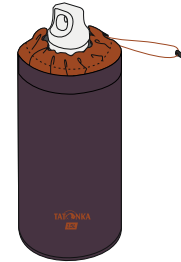

037 midnight plum



040 black

### 3299 THERMO BOTTLE COVER 0,6L BC

CORDURA® 500 den / 27 x 9 x 9 cm / 90 g / 0,6 l

**CORDURA**  
MOLLE  
KOMPATIBEL



332 stone grey olive

### 3300 THERMO BOTTLE COVER 1L BC

CORDURA® 500 den / 31 x 10 x 10 cm / 115 g / 1 l

**CORDURA**  
MOLLE  
KOMPATIBEL



332 stone grey olive

### 3298 BOTTLE POUCH 1L BC

CORDURA® 500 den / 24 x 12 x 12 cm / 236 g / 2 l

**CORDURA**  
MOLLE  
KOMPATIBEL



040 black



332 stone grey olive

### 3278 DUMP POUCH BC

Oxford 200 Recycled / CORDURA® 500 den / 32 x 21 x 9,5 cm / 90 g / 7l



332 stone grey olive

### 3145 BESTECKTASCHE BC

CORDURA® 500 den / 25 x 11 cm / 70 g / VE:3



332 stone grey olive

### 3146 BESTECKTASCHE

420 HD Nylon FD / Textreme 6.6 Recycled / 25 x 10 cm / 35 g / VE:3



040 black



047 bordeaux red



220 off black



279 elemental blue



286 sage green

### 2250 PLATE & CUTLERY POUCH **NEW**

Travel Tex Malange / 210 HD Nylon FD / 25 x 25 x 5,5 cm / 140 g



037 midnight plum



040 black

### 3262 CARRYING STRAP 38MM

Polyester Webbing Recycled / Textreme 6.6 Recycled / 120 x 3,8 cm / 105 g



040 black

### 3260 CARRYING STRAP 50MM

Polyester Webbing Recycled / Textreme 6.6 Recycled / 120 x 5 cm / 130 g



040 black

### 3261 SHOULDER PAD 50MM

Textreme 6.6 Recycled / 25 x 6 cm / 50 g



040 black

### 2893 EYE MASK

Square Rip Light / 22 x 8 cm / 20 g / VE:3



040 black

### 2906 TRAVEL TOWEL BAMBOO S

Bamboo Towel / 40 x 80 cm / 60 g



025 grey

### 2907 TRAVEL TOWEL BAMBOO M

Bamboo Towel / 60 x 120 cm / 125 g



025 grey

### 2908 TRAVEL TOWEL BAMBOO L

Bamboo Towel / 80 x 160 cm / 220 g



025 grey

### 3032 UNIVERSAL POUCH 20 X 10

CORDURA® 500 den / 20 x 10 x 5 cm / 120 g

CORDURA  
MOLLE  
KOMPATIBEL



040 black



332 stone grey olive

### 3033 UNIVERSAL POUCH 14 X 14

CORDURA® 500 den / 14 x 14 x 6 cm / 125 g

CORDURA  
MOLLE  
KOMPATIBEL



040 black



332 stone grey olive

### 3034 UNIVERSAL POUCH 20 X 14

CORDURA® 500 den / 20 x 14 x 5 cm / 150 g

CORDURA  
MOLLE  
KOMPATIBEL



040 black



332 stone grey olive

### 3035 UNIVERSAL POUCH 14 X 24

CORDURA® 500 den / 14 x 24 x 5 cm / 195 g

CORDURA  
MOLLE  
KOMPATIBEL



040 black



332 stone grey olive

### 3279 KNIFE POUCH LOCK BC

CORDURA® 500 den / 26 x 14 x 4 cm / 160 g

CORDURA



040 black



332 stone grey olive

### 2876 SMARTPHONE POUCH 6,2" BC

CORDURA® 500 den / 18 x 10 x 3 cm / 72 g

CORDURA



040 black



332 stone grey olive

### 2878 SMARTPHONE POUCH 6,9" BC

CORDURA® 500 den / 19 x 11 x 3 cm / 75 g

CORDURA

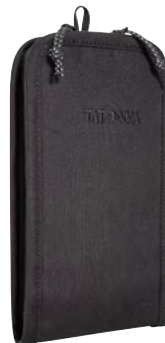

040 black



332 stone grey olive



## 2890 TOOL POUCH S BC

CORDURA® 500 den / 10 x 4 x 2 cm / 20 g / VE:3



040 black

332 stone grey olive

## 2891 TOOL POUCH M BC

CORDURA® 500 den / 11,5 x 5 x 2 cm / 25 g / VE:3



040 black

332 stone grey olive

## 2892 TOOL POUCH L BC

CORDURA® 500 den / 12 x 7 x 2,5 cm / 30 g / VE:3



040 black

332 stone grey olive

## 2916 TOOL POCKET "S"

CORDURA® 500 den / 12 x 3,8 x 1,5 cm / 25 g / VE:3



040 black

## 2917 TOOL POCKET "M"

CORDURA® 500 den / 12 x 5 x 1,5 cm / 35 g / VE:3



040 black

## 2918 TOOL POCKET "L"

CORDURA® 500 den / 12 x 7 x 2,5 cm / 60 g / VE:3



040 black

## 2938 NEOPREN CASE 1

Neopren / 12 x 8 x 3 cm / 28 g / VE:3



040 black

## 2939 NEOPREN CASE 2

Neopren / 15 x 7 x 3 cm / 30 g / VE:3



040 black

## 2933 NEOPREN ZIP BAG

Neopren / HF welding / 15 x 10 x 4 cm / 60 g / VE:3



040 black

## 2935 NEOPREN ZIP BAG 2

Neopren / 17 x 8 x 2 cm / 40 g / VE:3



040 black

## 2880 SMARTPHONE CASE L

NEW COLOR

Textreme 6.6 Recycled / 15,5 x 9,5 x 1 cm / 32 g / VE:3



● 037 midnight plum



● 040 black



## 2881 SMARTPHONE CASE XL

NEW COLOR

Textreme 6.6 Recycled / 17 x 10 x 1 cm / 35 g / VE:3

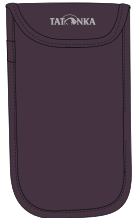

● 037 midnight plum

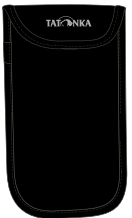

● 040 black

## 2882 SMARTPHONE CASE XXL

NEW COLOR

Textreme 6.6 Recycled / 18,5 x 11 x 1 cm / 40 g / VE:3

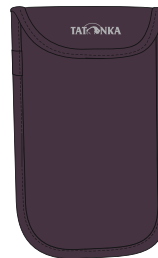

● 037 midnight plum

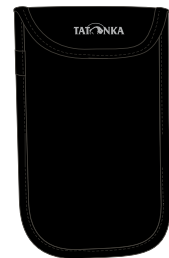

● 040 black

## 2886 SMARTPHONE CASE XL+

NEW COLOR

Textreme 6.6 Recycled / 18 x 10,5 x 2,5 cm / 50 g



● 037 midnight plum



● 040 black

## 2887 SMARTPHONE CASE XXL+

NEW COLOR

Textreme 6.6 Recycled / 19 x 11,5 x 2,5 cm / 55 g



● 037 midnight plum



● 040 black



## 2931 WP DRY BAG A6

70 den Nylon TPU / HF welding / 21 x 15 cm / 25 g



040 black



252 lime

## 2930 WP DRY BAG A5

70 den Nylon TPU / HF welding / 26 x 19 cm / 30 g



040 black



252 lime

## 2932 WP DRY BAG A4

70 den Nylon TPU / HF welding / 35,5 x 26 cm / 70 g

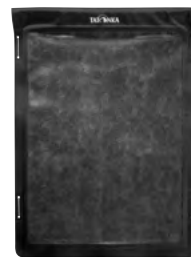

040 black



252 lime

## 2944 WP DRY BAG WIDE

70 den Nylon TPU / HF welding / 14 x 22 cm / 25 g



040 black



252 lime

## 3008 WP STUFFBAG LIGHT 2L

70 den Nylon TPU / HF welding / Ø 12 x 20 cm / 40 g / 2 l



040 black



252 lime

## 3020 WP STUFFBAG LIGHT 3,5L

70 den Nylon TPU / HF welding / Ø 14 x 20 cm / 50 g / 3,5 l



040 black



252 lime

## 3021 WP STUFFBAG LIGHT 7L

70 den Nylon TPU / HF welding / Ø 17 x 34 cm / 65 g / 7 l



040 black



252 lime

## 3056 WP STUFFBAG LIGHT 15L

70 den Nylon TPU / HF welding / Ø 20 x 40 cm / 108 g / 15 l



040 black



252 lime

NEW

## 3057 WP STUFFBAG LIGHT 25L

70 den Nylon TPU / HF welding / Ø 22,5 x 48 cm / 126 g / 25 l



040 black



252 lime

NEW

### 3068 WP STUFFBAG VALVE 15L

420 den Nylon TPU / HF welding / Ø 20 x 40 cm / 184 g / 15 l



040 black



252 lime

### 3072 WP STUFFBAG VALVE 25L

420 den Nylon TPU / HF welding / Ø 22,5 x 48 cm / 220 g / 25 l



040 black



252 lime

### 3073 WP STUFFBAG VALVE 48L

420 den Nylon TPU / HF welding / Ø 35 x 52 cm / 350 g / 48 l



040 black



252 lime



## ZIP POUCH

Laminated Square Mesh

3138 ZIP POUCH 15 X 10CM	10 x 15 cm / 30 g / VE:3	010 blue	040 black
3139 ZIP POUCH 20 X 15CM	15 x 20 cm / 40 g / VE:3	010 blue	040 black
3140 ZIP POUCH 25 X 20CM	20 x 25 cm / 60 g / VE:3	010 blue	040 black
3141 ZIP POUCH 35 X 25CM	25 x 35 cm / 100 g / VE:3	010 blue	040 black



## ZIP FLIGHT BAG

Vinyl

3134 ZIP FLIGHT BAG A6	16 x 12 cm / 15 g / VE:3	211 red orange	040 black
3135 ZIP FLIGHT BAG A5	22 x 18 cm / 25 g / VE:3	010 blue	040 black
3136 ZIP FLIGHT BAG A4	30,5 x 22 cm / 40 g / VE:3	025 grey	040 black



## DRY SACK

Tex Cover Recycled / versiegelt / taped

3041 DRY SACK 4L	Ø 14,5 x 25 cm / 4 l / 50 g / VE:3	211 red orange	040 black
3042 DRY SACK 10L	Ø 18,5 x 28 cm / 10 l / 60 g / VE:3	010 blue	040 black
3043 DRY SACK 18L	Ø 24 x 34 cm / 18 l / 70 g / VE:3	025 grey	040 black
3044 DRY SACK 30L	Ø 30 x 40 cm / 30 l / 80 g / VE:3	010 blue	040 black
3046 DRY SACK 80L	Ø 37,5 x 70 cm / 80 l / 150 g / VE:3	025 grey	040 black



## 3142 ZIP POUCH SET IV

Laminated Square Mesh / 240 g / VE:3

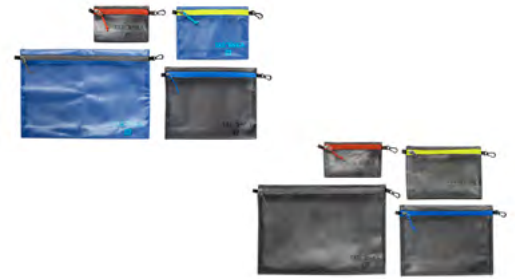

001 assorted

040 black

## 3137 ZIP FLIGHT BAG SET

Vinyl / 80 g / VE:3

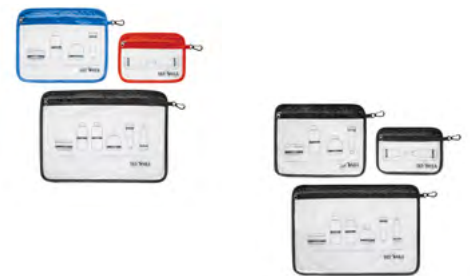

001 assorted

040 black

## 3047 DRY SACK SET III

Tex Cover Recycled / versiegelt / taped / 210 g



001 assorted

040 black

### 3188 COMPRESSION BAG 4L NEW

Tex Cover Recycled / Ø 15 x 32 cm / 56 g / 4 l



211 red orange

### 3189 COMPRESSION BAG 8L NEW

Tex Cover Recycled / Ø 19 x 47 cm / 84 g / 8 l



025 grey

### 3190 COMPRESSION BAG 12L NEW

Tex Cover Recycled / Ø 22 x 42 cm / 82 g / 12 l



010 blue

### 3191 COMPRESSION BAG 20L NEW

Tex Cover Recycled / Ø 25 x 59 cm / 116 g / 20 l



040 black

### 3054 STUFF SACK ZIP SET III

Embo Lining Recycled / 90 g / VE:3



001 assorted



040 black

### 3048 STUFF SACK SET III

Embo Lining Recycled / 65 g / VE:3



001 assorted



040 black

### 2246 MESH BAG M

Rubber Mesh PVC / 53 x 45 x 23 cm / 400 g

NEW



029 black elemental



040 black

### 2247 MESH BAG L

Rubber Mesh PVC / 45 x 52 x 34 cm / 512 g

NEW



029 black elemental



040 black

### 2248 MESH GRIP BAG

Rubber Mesh PVC / 48 x 33 x 10 cm / 428 g / 13 l

NEW



029 black elemental



040 black

### 2249 MESH SHOE BAG

Rubber Mesh PVC / 38 x 30 x 15 cm / 166 g

NEW



029 black elemental



040 black

## 3055 MESH BAG SET III

Embo Lining Recycled / Bug Beater Mesh Light / 175 g / VE:3



001 assorted

040 black

## 3037 MESH POCKET SET III

200 den Polyester Mesh / 100 g / VE:3



001 assorted

040 black

## RIEMEN ST-18 MM

Polyester Webbing Recycled

3210 RIEMEN ST-18MM/0,75M	75 x 1,8 cm / 32 g / VE:10	040 black
3211 RIEMEN ST-18MM/1,0M	100 x 1,8 cm / 36 g / VE:10	040 black
3212 RIEMEN ST-18MM/1,5M	150 x 1,8 cm / 42 g / VE:10	040 black
3213 RIEMEN ST-18MM/3,0M	300 x 1,8 cm / 84 g / VE:10	040 black



## EASY STRAP 18 MM

Polyester Webbing Recycled

3214 Easy Strap 18 mm 0,75 m	75 x 1,8 cm / 50 g / VE:10	040 black
3215 Easy Strap 18 mm 1,0 m	100 x 1,8 cm / 58 g / VE:10	040 black
3216 Easy Strap 18 mm 1,5 m	150 x 1,8 cm / 68 g / VE:10	040 black
3217 Easy Strap 18 mm 2,0 m	200 x 1,8 cm / 78 g / VE:10	040 black



## WEBBING

Polyester Webbing Recycled

3202 WEBBING 20MM / 5M	500 x 2 cm / 80 g / VE:3	040 black	331 olive
3203 WEBBING 25MM / 5M	500 x 2,5 cm / 100 g / VE:3	040 black	331 olive
3204 WEBBING 38MM / 5M	500 x 3,8 cm / 150 g / VE:3	040 black	331 olive
3205 WEBBING 50MM / 5M	500 x 5 cm / 200 g / VE:3	040 black	331 olive



### 4067 SHOT CUP SET

Edelstahl 18/8 / Ø 6 x 6 cm / 50 g / 60 ml / (Set)



### 4069 MUG "S"

Edelstahl 18/8 / Ø 7,5 x 9 cm / 95 g / 0,25 l / VE:10



### 4070 MUG

Edelstahl 18/8 / Ø 9 x 9,5 cm / 120 g / 0,45 l / VE:10



### 4071 EXPEDITION MUG

Edelstahl 18/8 / Ø 9 x 9 cm / 120 g / 0,35 l / VE:10



### 4077 MUG 350

Edelstahl 18/8 / Ø 9,5 x 9 cm / 85 g / 0,35 l



### 4078 PINT MUG

Edelstahl 18/8 / Ø 9 x 13 cm / 120 g / 0,5 l / VE:10



### 4100 THERMO PLUS

Edelstahl 18/8 / Ø 9,5 x 9,5 cm / 180 g / 0,35 l



### 4072 HANDLE MUG 500

Edelstahl 18/8 / Ø 10 x 8,5 cm / 150 g / 0,5 l



### 4073 HANDLE MUG 600

Edelstahl 18/8 / Ø 10 x 10,8 cm / 180 g / 0,6 l



### 4074 HANDLE MUG 850

Edelstahl 18/8 / Ø 10 x 13,5 cm / 210 g / 0,85 l



## 4075 HANDLE MUG LID

Edelstahl 18/8 / Ø 11 x 4,5 cm / 115 g



---

---

---

---

---

---

---

---

---

---

---

---

---

---

---

---

---

---

---

---

---

---

---

---

## 4172 HANDLE MUG 500 SET

Edelstahl 18/8 / Ø 11 x 12,5 cm / 265 g / 0,5 l



## 4173 HANDLE MUG 600 SET

Edelstahl 18/8 / Ø 11 x 14,5 cm / 295 g / 0,6 l



## 4174 HANDLE MUG 850 SET

Edelstahl 18/8 / Ø 11 x 17,5 cm / 325 g / 0,85 l



## 4080 THERMO 250

Edelstahl 18/8 / Ø 7,5 x 8,5 cm / 220 g / 0,25 l



## 4081 THERMO 350

Edelstahl 18/8 / Ø 7,5 x 12 cm / 280 g / 0,35 l



## 4082 THERMO MUG 250

Edelstahl 18/8 / Ø 7,5 x 8,5 cm / 150 g / 0,25 l



## 4083 THERMO MUG 350

Edelstahl 18/8 / Ø 7,5 x 11,5 cm / 210 g / 0,35 l



### 4029 PICNIC PLATE

Edelstahl 18/8 / Ø 16,5 x 3 cm / 100 g / VE:10



### 4031 SMALL PLATE

Edelstahl 18/8 / Ø 19 x 3 cm / 125 g / VE:10



### 4030 LARGE PLATE

Edelstahl 18/8 / Ø 23 x 3 cm / 170 g / VE:10



### 4032 SOUP PLATE

Edelstahl 18/8 / Ø 24 x 3,5 cm / 190 g / VE:10



### 4034 DEEP BOWL

Edelstahl 18/8 / Ø 18 x 6,5 cm / 180 g / VE:5



### 4036 BOWL WITH GRIP S

Edelstahl 18/8 / Ø 15,5 x 4,5 cm / 130 g / VE:5



### 4033 BOWL W. GRIP

Edelstahl 18/8 / Ø 18 x 5 cm / 165 g / VE:5



### 4064 BOWL 250ML

Edelstahl 18/8 / Ø 12,5 x 4,5 cm / 100 g / 0,25 l



### 4065 BOWL 500ML

Edelstahl 18/8 / Ø 15 x 5 cm / 135 g / 0,5 l



### 4012 PAN MULTI SET

Edelstahl 18/8 / Ø 21,5 x 3,3 cm / 215 g



### 4014 SMALL POT MULTI SET

Edelstahl 18/8 / Ø 16,5 x 7,5 cm / 160 g / 1,4 l



### 4015 LARGE POT MULTI SET

Edelstahl 18/8 / Ø 17,5 x 7,8 cm / 190 g / 1,6 l



### 4017 TEAPOT 1,0 LITER

Edelstahl 18/8 / Ø 15 x 7 cm / 350 g / 1,0 l



### 4016 TEAPOT 1,5 LITER

Edelstahl 18/8 / Ø 15 x 10 cm / 400 g / 1,5 l



### 4013 H2O POT 1,0L

Edelstahl 18/8 / Ø 15 x 7 cm / 300 g / 1 l



### 4009 H2O POT 1,5 L

Edelstahl 18/8 / Ø 15 x 10,5 cm / 340 g / 1,5 l



### 4006 FAMILY POT 6,0 L

Edelstahl 18/8 / Ø 26 x 15 cm / 855 g / 6 l



### 4001 KETTLE 1,0L

Edelstahl 18/8 / Ø 14,5 x 10,5 cm / 340 g / 1 l



### 4002 KETTLE 1,6L

Edelstahl 18/8 / Ø 17,8 x 11,5 cm / 460 g / 1,6 l



### 4003 KETTLE 2,5L

Edelstahl 18/8 / Ø 20 x 12,5 cm / 580 g / 2,5 l



### 4004 KETTLE 4,0L

Edelstahl 18/8 / Ø 23,5 x 14 cm / 770 g / 4 l



### 4005 KETTLE 6,0L

Edelstahl 18/8 / Ø 28,5 x 16 cm / 975 g / 6 l



### 4058 KETTLE II 1,0L

Edelstahl 18/8 / Ø 14,5 x 8,5 cm / 290 g / 1 l



### 4059 KETTLE II 1,6L

Edelstahl 18/8 / Ø 17,5 x 9 cm / 395 g / 1,6 l



### 4060 KETTLE II 2,5L

Edelstahl 18/8 / Ø 20 x 10,5 cm / 530 g / 2,5 l



### 4061 KETTLE II 4,0L

Edelstahl 18/8 / Ø 23,5 x 11,5 cm / 690 g / 4 l



### 4129 HOBO BURNER

Edelstahl 18/8 / Ø 14,5 x 11,5 cm / 310 g



### 4010 MULTI SET + A. BURNER

Edelstahl 18/8 / Ø 21,5 x 10,5 cm / 1,21 kg / (Set)



### 4133 ALCOHOL BURNER SET

Edelstahl 18/8 / Ø 8,5 x 13 cm / 520 g / (Set)



### 4124 POT GRIPPER

Aluminium / 12 x 2,5 x 3,5 cm / 60 g



### 4025 FALTWINDSCHUTZ 8TLG

Aluminium / 65 x 20 x 2 cm / 220 g



### 4026 FALTWINDSCHUTZ 10TLG

Aluminium / 82 x 24 x 2 cm / 330 g

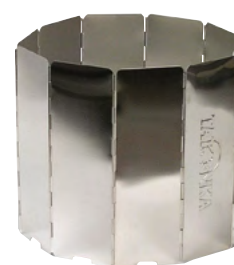

### 4131 BURNER SET

Edelstahl 18/8 / 210 g / 120 ml / (Set)



### 4132 STAND ALCOHOL BURNER

Edelstahl 18/8 / 7,5 x 3 cm / 85 g



### 4126 ALCOHOL BURNER

Edelstahl 18/8 / Ø 7,5 x 5,5 cm / 95 g / 120 ml



### 4128 FLAME ADJUSTER

Edelstahl 18/8 / Ø 7,65 x 2,5 cm / 30 g





### 4118 CUTLERY SET I

Edelstahl 18/8 / 18 x 4 cm / 100 g



### 4125 CUTLERY SET II

Edelstahl 18/8 / 18 x 4 cm / 160 g



### 4121 SPOON SET (4 PCS)

Kokos / 16 x 2,5 x 0,7 cm / 40 g / (Set) / VE:5



### 4122 COOKING SPOON SET

Kokos / 21 x 5 x 0,5 cm / 45 g / (Set) / VE:5



### 4053 BBQ TONG

Edelstahl 18/8 / 28 x 6,5 x 2,5 cm / 150 g / VE:3



### 4109 WOODFIBRE CUTTING BOARD 15CM

Woodfibre / Ø 15 x 6 cm / 147 g



### 4110 WOODFIBRE CUTTING BOARD 18CM

Woodfibre / Ø 18 x 6 cm / 215 g



### 4107 KETTLE II SET

Edelstahl 18/8 / Ø 20 x 10,5 cm / 1,16 kg / (Set)



### 4007 MULTI POT SET

Edelstahl 18/8 / Ø 21,5 x 8 cm / 540 g / (Set)



### 4113 CAMP SET REGULAR

Edelstahl 18/8 / Ø 17,3 x 6 cm / 495 g / (Set)



### 4114 CAMP SET LARGE

Edelstahl 18/8 / Ø 17,3 x 8 cm / 525 g / (Set)



### 4115 SCOUT SET 0,6 L

Edelstahl 18/8 / Ø 14,5 x 6 cm / 180 g / 0,6 l / (Set)



### 4116 SCOUT SET 1,0 L

Edelstahl 18/8 / Ø 18,5 x 7 cm / 260 g / 1 l / (Set)



### 4117 SCOUT SET 1,5 L

Edelstahl 18/8 / Ø 18,5 x 8,5 cm / 280 g / 1,5 l / (Set)



### 4108 POT SET BC 1,4L

Edelstahl 18/8 / Ø 13 x 13,5 cm / 495 g / 1,4 l



### 4008 POT SET FOR GAS CARTRIDGE 450 + BURNER

Edelstahl 18/8 / Ø 12 x 19 cm / 460 g / 1,5 l / (Set)



### 4000 COOKSET REGULAR

Edelstahl 18/8 / Ø 19 x 9 cm / 695 g / (Set)



### 4024 FAMILY COOK SET "L"

Edelstahl 18/8 / Ø 26 x 15 cm / 2,72 kg / (Set)



### 4120 PICNIC SET

Edelstahl 18/8 / Ø 16,5 x 13 cm / 790 g / (Set)



### 4037 FOOD BOWL 0,5L

Edelstahl 18/8 / Ø 15,5 x 6 cm / 260 g / 0,5 l

BPA  
FREE



### 4038 FOOD BOWL 0,75L

Edelstahl 18/8 / Ø 19 x 6 cm / 350 g / 0,75 l

BPA  
FREE



### 4039 FOOD BOWL 1,0L

Edelstahl 18/8 / Ø 20 x 6 cm / 410 g / 1 l

BPA  
FREE



### 4042 FOODCONTAINER 0,75L

Edelstahl 18/8 / Ø 15,5 x 8 cm / 300 g / 0,75 l

BPA  
FREE



### 4043 FOODCONTAINER 1,0L

Edelstahl 18/8 / Ø 15,5 x 9,5 cm / 310 g / 1 l

BPA  
FREE



### 4044 FOODCONTAINER 1,5L

Edelstahl 18/8 / Ø 19 x 9,5 cm / 420 g / 1,5 l

BPA  
FREE



### 4045 FOODCONTAINER 2,0L

Edelstahl 18/8 / Ø 20 x 9,5 cm / 460 g / 2 l

BPA  
FREE



### 4137 LUNCH BOX I 800

Edelstahl 18/10 / 17,1 x 13,3 x 5,8 cm / 225 g / 0,8 l



### 4136 LUNCH BOX I 1000

Edelstahl 18/10 / 19 x 14,4 x 6 cm / 245 g / 1 l



## 4138 LUNCH BOX II 800

Edelstahl 18/10 / 17,1 x 13,3 x 5,8 cm / 245 g / 0,8 l



## 4139 LUNCH BOX III 1000

Edelstahl 18/10 / 19 x 14,4 x 6 cm / 285 g / 1 l



## 4200 LUNCH BOX I 800 LOCK

Edelstahl 18/10 / 17 x 13,3 x 6 cm / 285 g / 0,8 l

BPA  
FREE



## 4201 LUNCH BOX I 1000 LOCK

Edelstahl 18/10 / 19 x 14,4 x 6 cm / 330 g / 1 l

BPA  
FREE



## 4202 LUNCH BOX II 800 LOCK

Edelstahl 18/10 / 17 x 13,3 x 6 cm / 290 g / 0,8 l

BPA  
FREE



## 4203 LUNCH BOX II 1000 LOCK

Edelstahl 18/10 / 19 x 14,4 x 6 cm / 370 g / 1 l

BPA  
FREE



## 4204 LUNCH BOX I 800 BAMBOO

Edelstahl 18/10 / 16,5 x 12,8 x 6 cm / 280 g / 0,8 l



## 4205 LUNCH BOX I 1000 BAMBOO

Edelstahl 18/10 / 18,4 x 13,8 x 6 cm / 310 g / 1 l



## 3630 FALTKANISTER 5L

Polyethylene / 24 x 6 cm / 140 g / 5 l

BPA  
FREE



## 3635 FALTKANISTER 10L

Polyethylene / 27,5 x 6 cm / 250 g / 10 l

BPA  
FREE



## HOT + COLD STUFF

Edelstahl 18/8

- 4148 HOT + COLD STUFF 0,35L Ø 6,7 x 22 cm / 0,35 l / 250 g
- 4150 HOT + COLD STUFF 0,45L Ø 6,7 x 26,8 cm / 0,45 l / 290 g
- 4155 HOT + COLD STUFF 0,75L Ø 8,3 x 27,4 cm / 0,75 l / 440 g
- 4160 HOT + COLD STUFF 1,0L Ø 9,1 x 30 cm / 1 l / 500 g

BPA  
FREE



## HOT + COLD STUFF BAMBOO LID

Edelstahl 18/8

- 4195 HOT + COLD STUFF BAMBOO LID 500 Ø 7 x 22 cm / 0,5 l / 300 g
- 4196 HOT + COLD STUFF BAMBOO LID 750 Ø 7,5 x 26,5 cm / 0,75 l / 380 g
- 4197 HOT + COLD STUFF BAMBOO LID 1000 Ø 8 x 31,5 cm / 1 l / 450 g

BPA  
FREE



## STAINLESS STEEL BOTTLE

Edelstahl 18/8

- 4181 STAINLESS STEEL BOTTLE 0,5L Ø 7 x 19 cm / 0,5 l / 110 g
- 4182 STAINLESS STEEL BOTTLE 0,6L Ø 7 x 21,5 cm / 0,6 l / 125 g
- 4183 STAINLESS STEEL BOTTLE 0,75L Ø 7 x 24 cm / 0,75 l / 140 g
- 4184 STAINLESS STEEL BOTTLE 1,0L Ø 7,8 x 26,5 cm / 1 l / 200 g

BPA  
FREE



## STAINLESS STEEL BOTTLE PREMIUM

Edelstahl 18/8

- 4190 STEEL BOTTLE PREMIUM 0,5L Ø 7 x 19,5 cm / 0,5 l / 140 g
- 4191 STEEL BOTTLE PREMIUM 0,75L Ø 7 x 24 cm / 0,75 l / 165 g
- 4192 STEEL BOTTLE PREMIUM 1,0L Ø 8 x 24,5 cm / 1 l / 225 g

BPA  
FREE



## 4194 SPORTS LID

Polypropylene / Ø 55 x 75 mm / 35 g

BPA  
FREE



## 4193 BAMBOO LID

Edelstahl 18/8 / Bamboo / Ø 55 x 40 mm / 50 g

BPA  
FREE





## 2295 FISCHERSTUHL

420 HD Nylon FD / 42 x 25 x 14 cm / 1,10 kg / 20 l



331 olive

## 2296 PETRI CHAIR

420 HD Nylon FD / 54 x 32 x 20 cm / 1,80 kg / 35 l



331 olive

## 3277 SEAT MAT BC 35 X 45CM

CORDURA® 500 den / PE-Sponge/ Foil / 35 x 45 cm / 90 g



332 stone grey olive

## 2973 ALU-SITZKISSEN 35 X 45CM

PE-Sponge/ Foil / 35 x 45 cm / 30 g / VE:20



027 silver

## 2987 ALU-SEAT MAT 45 X 90CM

PE-Sponge/ Foil / 90 x 45 cm / 100 g / VE:5



027 silver

## 2988 ALU-SEAT MAT 50 X 180CM

PE-Sponge/ Foil / 180 x 50 cm / 205 g / VE:5



027 silver

## 3235 FOLDABLE SEAT MAT 26 X 34CM

EVA Foam / 26 x 34 cm / 50 g / VE:5

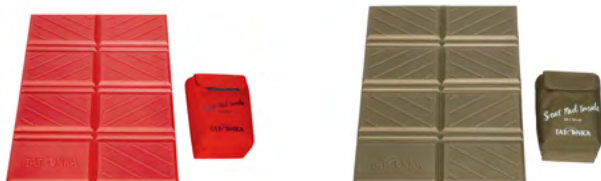

015 red

331 olive





## 2636 MOSKITO KOPFSCHUTZ SIMPLE

Bug Beater Mesh Light / 35 x 25 x 25 cm / 30 g / VE:10



036 cub

## 2654 MOSKITOSTOFF 145 X 100

Bug Beater Mesh Light / 100 x 145 cm / 50 g

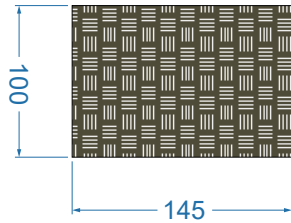

## 2655 MOSKITOSTOFF 145 X 300

Bug Beater Mesh Light / 145 x 300 cm / 150 g

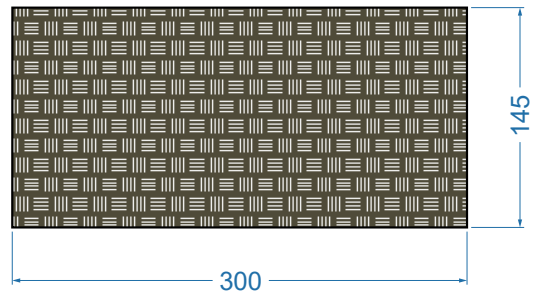

## 2474 SINGLE MESH TENT

Bug Beater Mesh Light / 235 x 120 x 95 cm / 580 g



331 olive

## 2624 SINGLE MOSKITO DOME

Bug Beater Mesh Light / 220 x 90 x 110 cm / 1,20 kg



036 cub

## 2625 DOUBLE MOSKITO DOME

Bug Beater Mesh Light / 220 x 130 x 134 cm / 1,50 kg



036 cub

## 2485 TARP 1

68 den Polyester 210T PU / 425 x 445 cm / 1,75 kg

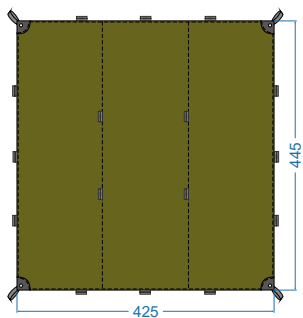

333 light olive

## 2490 TARP 2

68 den Polyester 210T PU / 285 x 300 cm / 900 g

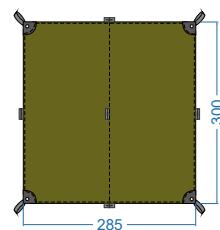

333 light olive

## 2493 TARP 4

68 den Polyester 210T PU / 285 x 400 cm / 1,20 kg

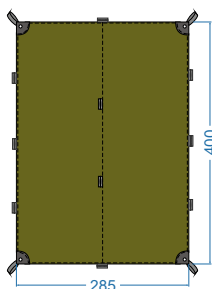

333 light olive

## 2494 VAN TARP

68 den Polyester 210T PU / 250 x 250 cm / 960 g



333 light olive

## 2465 TARP 1 TC

65/35 Polycotton / 425 x 445 cm / 2,80 kg

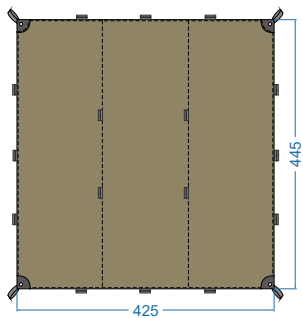

321 sand beige

## 2466 TARP 2 TC

65/35 Polycotton / 285 x 300 cm / 1,30 kg

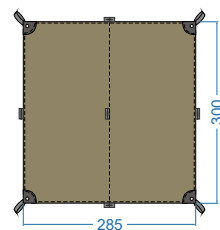

321 sand beige

## 2468 TARP 4 TC

65/35 Polycotton / 285 x 400 cm / 1,75 kg

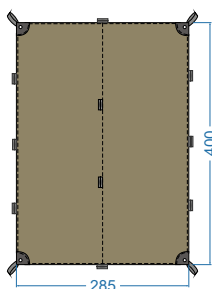

321 sand beige

## 2467 TARP 3 TC

65/35 Polycotton / 400 x 400 cm / 2,25 kg

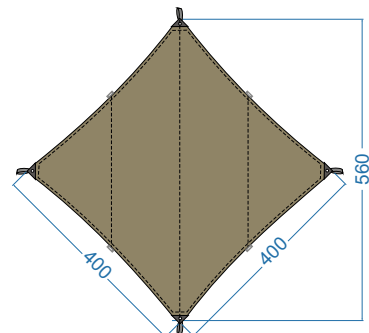

321 sand beige

## 2492 VAN TARP TC

65/35 Polycotton / 250 x 250 cm / 1,40 kg



321 sand beige



## 2475 TARP WING 1 LT

20 den Nylon6 RS Si / 315 x 140 cm / 280 g

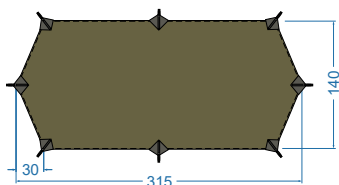

332 stone grey olive

## 2476 TARP WING 2 LT

20 den Nylon6 RS Si / 315 x 215 cm / 330 g

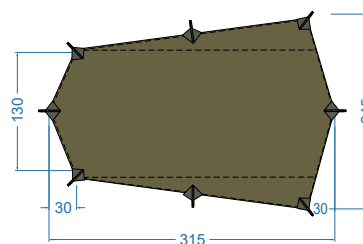

332 stone grey olive

## 2477 TARP WING 3 LT

20 den Nylon6 RS Si / 320 x 280 cm / 405 g

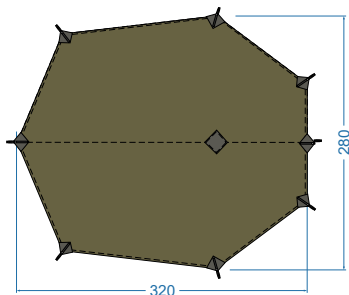

332 stone grey olive



# FLOORSHEET TYVEK

PE Tyvek

**3718 FLOORSHEET TYVEK I 120 X 220CM**

120 x 220 cm / 115 g

**3719 FLOORSHEET TYVEK II 150 X 220CM**

150 x 220 cm / 145 g

**3720 FLOORSHEET TYVEK III 180 X 220CM**

180 x 220 cm / 175 g

**3721 FLOORSHEET TYVEK IV 240 X 220CM**

240 x 220 cm / 230 g

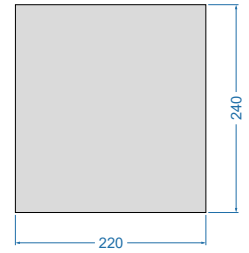
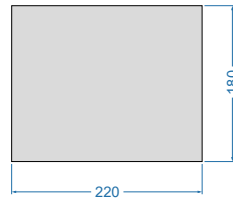
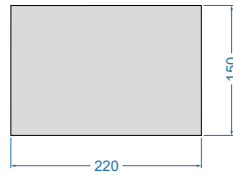
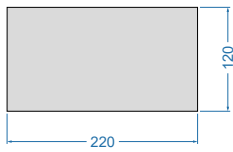

## 3700 ZELTUNTERL. 250 X 220CM

Reinforced PE-Foil / 250 x 220 cm / 880 g

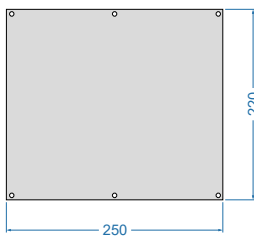

## 3705 ZELTUNTERL. 230 X 160CM

Reinforced PE-Foil / 230 x 160 cm / 600 g

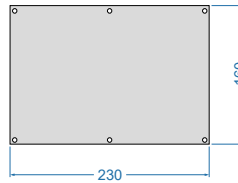

## 3740 FLOOR SHEET LT KYRKJA

Cover Tex Pro / 243 x 110 cm / 190 g

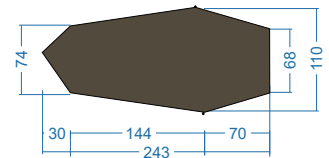

332 stone grey olive

## 3741 FLOOR SHEET LT GARGIA 2

Cover Tex Pro / 350 x 145 cm / 360 g

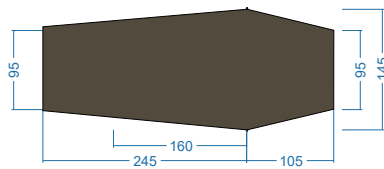

332 stone grey olive

## 3742 FLOOR SHEET LT GARGIA 3

Cover Tex Pro / 360 x 175 cm / 455 g

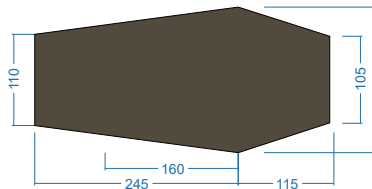

332 stone grey olive

## 3743 FLOOR SHEET LT ROKUA 2

Cover Tex Pro / 420 x 145 cm / 440 g

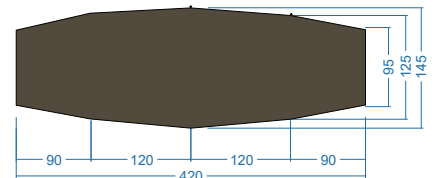

332 stone grey olive

## 3744 FLOOR SHEET LT ROKUA 3

Cover Tex Pro / 450 x 175 cm / 590 g

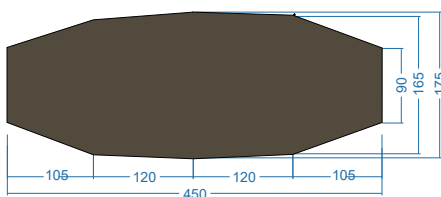

332 stone grey olive

## 3745 FLOOR SHEET LT OKISBA

Cover Tex Pro / 390 x 145 cm / 425 g

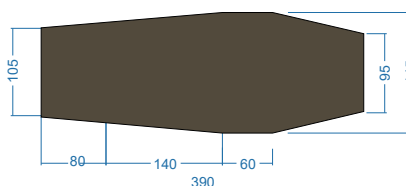

332 stone grey olive

## 3746 FLOOR SHEET LT POLAR 3

Cover Tex Pro / 410 x 175 cm / 570 g

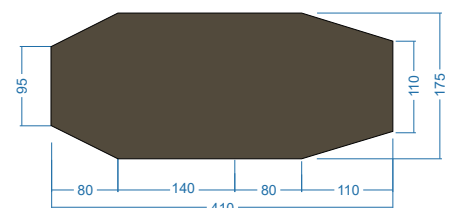

332 stone grey olive





## 3809 PEG POUCH

Square Rip Light / 420 HD Nylon FD / 28 x 11 cm / 15 g / VE:3



## 3800 ZELTHERING 19CM 10PCS

Aluminium / 19 cm / 190 g



## 3802 ALU ZELTHERING 19CM

Aluminium / 19 cm / 19 g/pcs / VE:100



## 3804 ZELTHERING / TENT PEG ALLROUND 19CM 6PCS

Aluminium / 19 cm / 19 g/pcs



015 red

## 3805 ZELTHERING / TENT PEG LIGHT 17CM 6PCS

Aluminium / 17 cm / 12 g/pcs



015 red

## 3806 ZELTHERING / TENT PEG PRO 15CM 6PCS

Aluminium / 15 cm / 10 g/pcs



127 orange

## 3807 ZELTHERING / TENT PEG PRO 19CM 6PCS

Aluminium / 19 cm / 14 g/pcs



015 red

## 3808 ZELTHERING / TENT PEG PRO 25CM 6PCS

Aluminium / 25 cm / 35 g/pcs



301 gold



## 2510 KYRKJA LT

20 den Nylon 6 Ripstop Si / 0,97 kg (min) / 1,34 kg

## 2427 GRÖNLAND 2 VENT LT

20 den Nylon 6 Ripstop Si / 2,20 kg (min) / 2,38 kg



332 stone grey olive



332 stone grey olive

## 2602 GARGIA 2

20 den Nylon 6 Ripstop Si / 2,00 kg (min) / 2,15 kg

## 2604 GARGIA 3

20 den Nylon 6 Ripstop Si / 2,25 kg (min) / 2,40 kg



332 stone grey olive



332 stone grey olive

## 2606 ROKUA 2

20 den Nylon 6 Ripstop Si / 2,40 kg (min) / 2,60 kg

## 2608 ROKUA 3

20 den Nylon 6 Ripstop Si / 2,75 kg (min) / 2,95 kg



332 stone grey olive

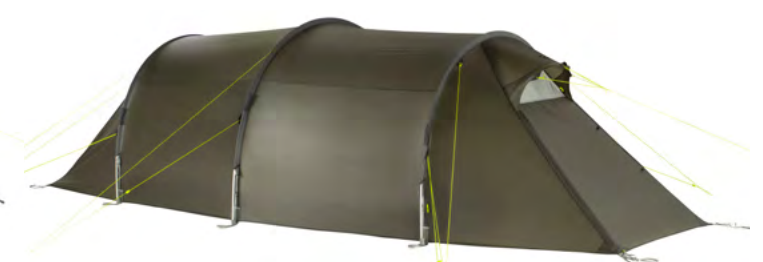

332 stone grey olive

## 2509 KYRKJA

30 den Nylon 6.6 Ripstop250T Si / 1,35 kg (min) / 1,45 kg



070 green

## 2597 OKISBA

30 den Nylon 6.6 Ripstop250T Si / 2,50 kg (min) / 2,70 kg



070 green



## 2599 POLAR 3

30 den Nylon 6.6 Ripstop250T Si / 3,10 kg (min) / 3,30 kg



070 green



## 2401 KOLI

68 den Polyester 210T PU / 1,60 kg (min) / 1,70 kg



333 light olive



## 2550 NARVIK 2

68 den Polyester 210T PU / 2,50 kg (min) / 2,80 kg



333 light olive

## 2551 NARVIK 3

68 den Polyester 210T PU / 2,80 kg (min) / 3,10 kg



333 light olive

## 2555 GRÖNLAND 2

68 den Polyester 210T PU / 2,80 kg (min) / 3,10 kg



333 light olive

## 2556 GRÖNLAND 3

68 den Polyester 210T PU / 3,40 kg (min) / 3,70 kg



333 light olive

## 2428 GRÖNLAND 3 VENT

68 den Polyester 210T PU / 3,50 kg (min) / 3,80 kg



333 light olive

## 2451 ARCTIS 2.235 PU

68 den Polyester 210T PU / 2,80 kg (min) / 3,10 kg



333 light olive

## 2453 ARCTIS 3.235 PU

68 den Polyester 210T PU / 3,20 kg (min) / 3,50 kg



333 light olive

## 2455 ALASKA 2.235 PU

68 den Polyester 210T PU / 3,50 kg (min) / 3,80 kg



333 light olive

## 2457 ALASKA 3.235 PU

68 den Polyester 210T PU / 4,20 kg (min) / 4,50 kg



333 light olive

## 2449 ALASKA 3 PLUS

68 den Polyester 210T PU / 4,13 kg (min) / 6,28 kg



333 light olive



## 2430 BUFFIN 4

68 den Polyester 210T PU / 4,40 kg (min) / 4,70 kg



333 light olive

## 2459 ALASKA 4 PU

68 den Polyester 210T PU / 5,20 kg (min) / 5,50 kg



333 light olive

## 2584 ALASKA 3 DLX

68 den Polyester 210T PU / 5,60 kg (min) / 5,90 kg



333 light olive

## 2585 ALASKA FAMILY DLX

68 den Polyester 210T PU / 8,80 kg (min) / 9,20 kg



333 light olive

## 2446 FAMILY CAMP

68 den Polyester 210T PU / 7,00 kg (min) / 7,30 kg



333 light olive

## 2447 FAMILY CAMP EXTENSION

70 den Nylon Ripstop 190T WR / 1,10 kg (min) / 1,25 kg



049 ash grey

## 2435 FAMILY TREK II

68 den Polyester 210T PU / 9,89 kg (min) / 10,30 kg



333 light olive

## 2436 FAMILY TREK II EXTENSION

70 den Nylon Ripstop 190T WR / 1,97 kg



049 ash grey

## 2442 VAN CAMP BASIC

68 den Polyester 210T PU / 5,95 kg



333 light olive

## 2448 VAN CAMP

68 den Polyester 210T PU / 7,50 kg



333 light olive

## 3765 VAN CAMP FLOOR SHEET

Reinforced PE-Foil / 305 x 320 cm / 1,60 kg





## TREKKING-KAMPAGNE\*



P419.318 Sticker  
8 cm Expedition Life



P420.318 Sticker  
8 cm Contour



P421.318 Sticker  
9,8 cm Collage



P419.319 Sticker  
8 cm Expedition Life



P420.319 Sticker  
8 cm Contour



P421.319 Sticker  
9,8 cm Collage

## BACKPACKING-KAMPAGNE\*



P410



P415

- P410.000 DIN-A3-Aufsteller "Backpacking"  
P415.000 DIN-A1-Hängeschild "Backpacking"

## EVERYDAY-KAMPAGNE\*



P412



P417

- P412.000 DIN-A3-Aufsteller "Everyday"  
P417.000 DIN-A1-Hängeschild "Everyday"

## HIKING-KAMPAGNE



P411



P416

- P411.000 DIN-A3-Aufsteller "Hiking"  
P416.000 DIN-A1-Hängeschild "Hiking"

## OPEN FACTORY/TRACEABILITY-KAMPAGNE

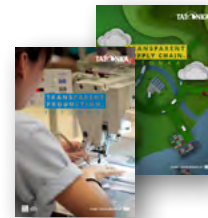

P272

- P272.000 DIN A3-Aufsteller "Open Factory/Traceability"



## BUSHCRAFT-KAMPAGNE



P373

P374

P408

P399.000 Aufkleber BC Lets Get Lost

P373.000 DIN A3 - Aufsteller "Bushcraft"  
 P374.000 DIN A1 - Hängeschild "Bushcraft"  
 P408.001 Counter Display BC inkl. Patches

## TATONKA VERTRIEBSUNTERLAGEN

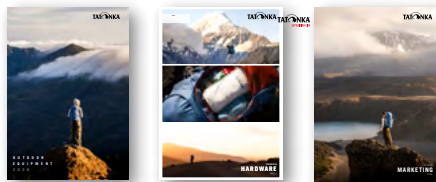

P106

P116

P233

P106.850 Tatonka Katalog  
 P115.850 Tatonka Overview Hardware I  
 P233.000 Marketing Planer (nur digital)

## TATONKA WEIGHT SYSTEM



P020

P021

P020.001 Tatonka Weight System 3kg  
 P021.001 Tatonka Weight System 5kg

## TATONKA KATALOGANFORDERUNG



P084

P084.001 DIN A6 - Postkarte Tatonka  
 "Kataloganforderung"

## VELCRO RELEASE TOOL FCL



P015.040

## TATONKA WERBEARTIKEL



P014

P014.000 Tatonka Kugelschreiber



P018

P018.001 Tatonka Tasse 3er Set

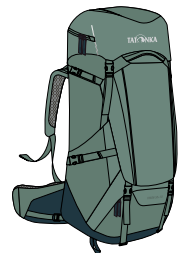

P029

P029.286 Mega Yukon

## TATONKA DISPLAYS



P049



P051

- P049.000 Display 750x1600mm  
 P051.000 TA Magnets. Accessoire Display

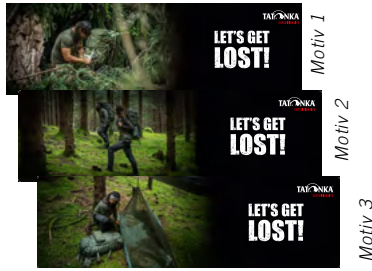

- P377.318 TA Magnetschild BC Motiv 1  
 P377.319 TA Magnetschild BC Motiv 2  
 P377.314 TA Magnetschild BC Motiv 3



- P017.332 TA Lasercut POS 100x60cm  
 (nicht bestückt)



### TATONKA BARREL DISPLAY PAKET

- P048.000 Tatonka Barrel Display  
 P095.000 Tatonka Barrel Display Boden  
 P059.M01 TA A2 Magnetschild Barreldisplay  
 P061.000 TA Magnetschild Barrel Display Fahne

- Nicht bestückt -



### TATONKA RUCKSACK DISPLAY PAKET

- P045.000 Rucksack Display  
 P041.000 TA Rucksack Display Boden  
 P101.000 TA Magnetschild Rucksack Display rund

Passende Magnetschilder:

- P032.M02 TA A2 Magnetschild Rucksackdisplay Trekking  
 P032.M03 TA A2 Magnetschild Rucksackdisplay Backpacking  
 P032.M04 TA A2 Magnetschild Rucksackdisplay Hiking  
 P102.M05 TA A3 Querformat Magnetschild Rucksackdisplay Bushcraft

## TATONKA DISPLAYAUSSTATTUNG



P062



P264

- P062.000 TA First Aid Magnetschild hoch  
 P264.000 TA RFID Magnetschild hoch  
 P053.000 Tatonka Schleifenhaken 20 cm



P053



P039



P040



P031

- P039.001 Tatonka Table Flag  
 P035.040 Tatonka Fahne Pro 230cm  
 P031.040 Tatonka Fahne 400cm

## LOGO T-SHIRT MOUNTECH VIETNAM

100% Bio-Baumwolle



049 ash grey

P145.049 Logo M's T-Shirt Mountech Vietnam  
P146.049 Logo W's T-Shirt Mountech Vietnam

## TATONKA T-SHIRT

100% Bio-Baumwolle



800 grey heather

P085.800 Tatonka T-Shirt M's  
P086.800 Tatonka T-Shirt W's

## P147 TA BUSHCRAFT T-SHIRT

100% Bio-Baumwolle



331 olive

## P394 TA NATURE GRID LONGSLEEVE

100% Baumwolle



040 black

## P150 TATONKA HOODIE M'S

80% Baumwolle, 20% Polyester



800 grey heather

## P151 TATONKA HOODIE W'S

80% Baumwolle, 20% Polyester



800 grey heather



## P398 CONTOUR OVERSIZE SHIRT M'S

100% Baumwolle



040 black

108 sand

P398.040 Tatonka Contour Oversize Shirt M's  
P398.108 Tatonka Contour Oversize Shirt M's

## P396 COLLAGE OVERSIZE SHIRT M'S

100% Baumwolle



040 black

108 sand

P396.040 Tatonka Collage Oversize Shirt M's  
P396.108 Tatonka Collage Oversize Shirt M's

## P397 CONTOUR OVERSIZE SHIRT W'S

100% Baumwolle



040 black

101 white sand

P397.040 Tatonka Contour Oversize Shirt W's  
P397.101 Tatonka Contour Oversize Shirt W's

## P395 COLLAGE OVERSIZE SHIRT W'S

100% Baumwolle



040 black

101 white sand

P395.040 Tatonka Collage Oversize Shirt W's  
P395.101 Tatonka Collage Oversize Shirt W's

TATONKA SHORTCUTS

<b>BC</b>	Bushcraft	<b>JR</b>	Junior
<b>DLX</b>	Deluxe	<b>LT</b>	Light
<b>HD</b>	High Density	<b>PU</b>	Polyurethan
<b>IP 64</b>	Dustproof Protection against water splashes from all directions; determination of the protection rating through standardised testing	<b>RFID</b>	Radio Frequency Identification
<b>IPX 7</b>	Protection against temporary submersion (1 metre water depth, 30 minutes) Determination of the protection rating through a standardised test	<b>SQZY</b>	Squeezy
		<b>WP</b>	Waterproof



## TRACEABILITY BY TATONKA – TRANSPARENCY CREATES TRUST

**We are convinced that transparency is part of our social responsibility. That is why we disclose all stages of the manufacturing and transport process of our products.**

On our **Traceability website**, you can trace the path of every Tatonka product from the purchase of materials to production and shipping to the country of destination by means of the serial/batch number. We show who supplied the materials for the products, where the product was sewn and which transport routes and modes of transport were used until the finished product reached its destination

Due to our own production, we have access to all information concerning the production process. We collect and manage all the data ourselves and use it to clearly **trace the supply chain for every Tatonka product.**

